

2.2.5

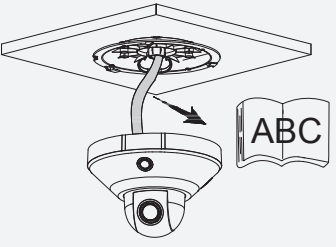

2.2.6

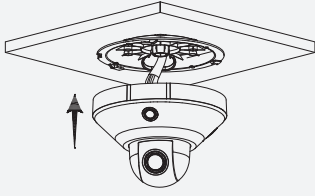

2.2.7

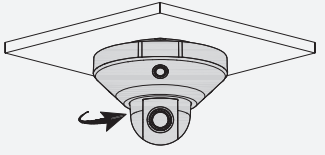

A

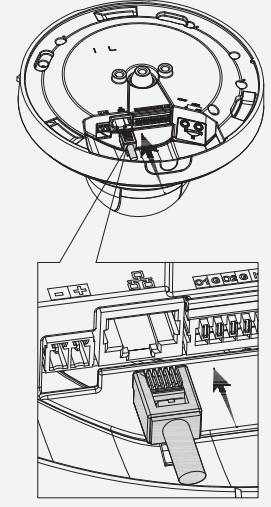

B

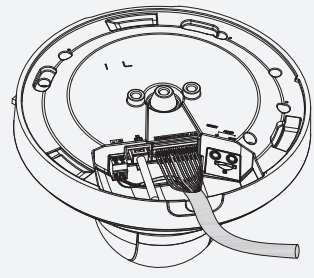
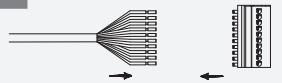

C

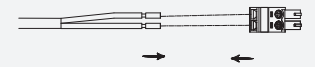

1

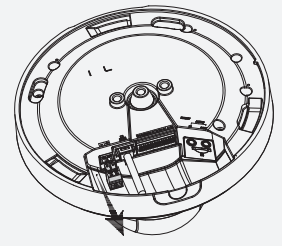

2

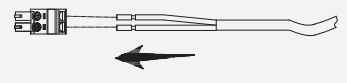

3

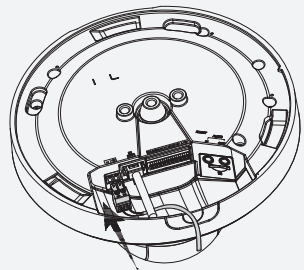

3.1

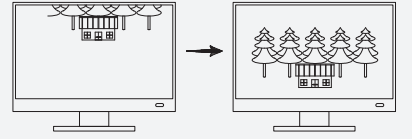
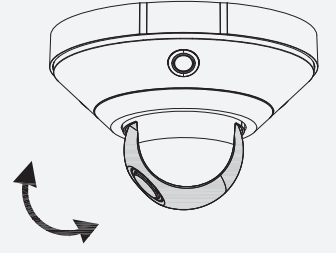

3.2

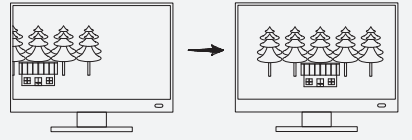
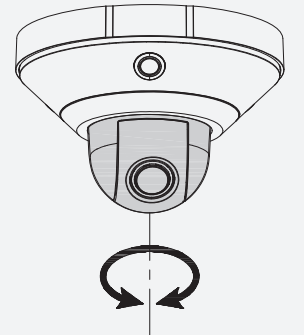

# Multi-sensor Panoramic Network Camera

Installation Guide

V1.0.0

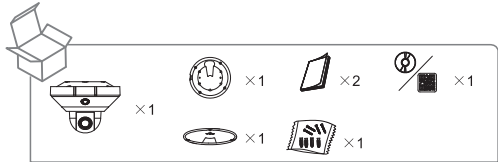

1.1

Optional

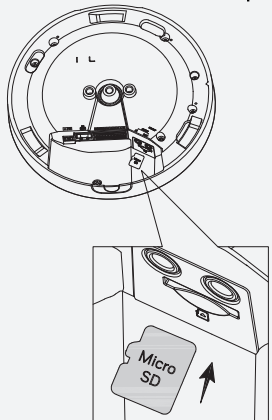

2.1.1

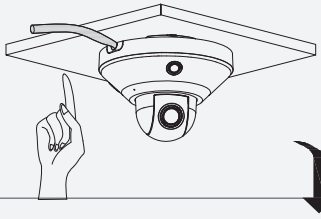

2.1.2

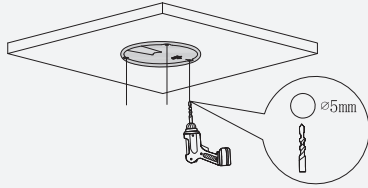

2.1.3

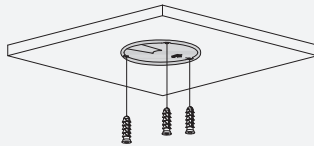

2.1.4

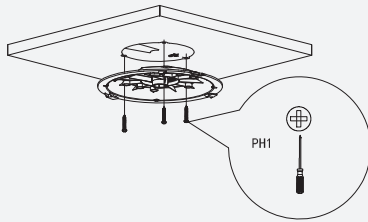

2.1.5

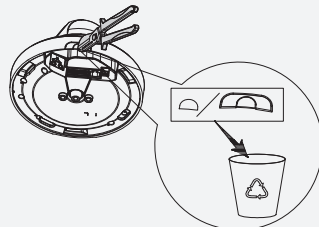

2.1.6

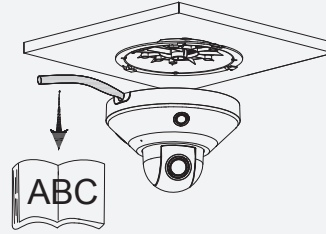

2.1.7

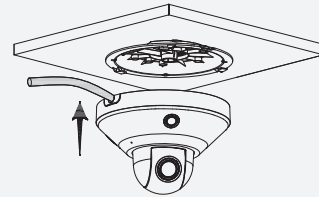

2.1.8

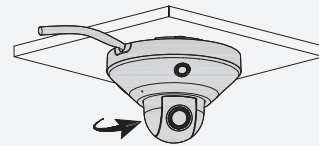

2.2.1

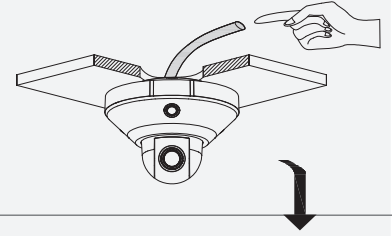

2.2.2

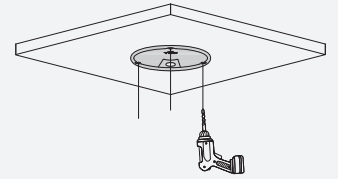

2.2.3

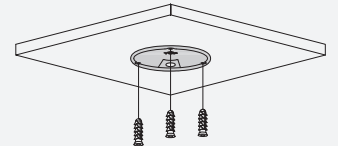

2.2.4

