

DH-IPC-HFW3241T-ZS

2MP IR Vari-focal Bullet WizSense Network Camera



Wiz Sense

Launched by Dahua Technology, WizSense is a series of AI products and solutions that adopt independent AI chip and deep learning algorithm. It focuses on human and vehicle with high accuracy, enabling users to fast act on defined targets. Based on Dahua's advanced technologies, WizSense provides intelligent, simple and inclusive products and solutions.

Series Overview

With advanced deep learning algorithm, Dahua WizSense 3 Series network camera supports intelligent functions, such as perimeter protection and smart motion detection. With starlight technology, this series camera provides a better image effect in the condition of low illuminance.

Functions

SMD Plus

With intelligent algorithm, Dahua Smart Motion Detection technology can categorize the targets that trigger motion detection and filter the motion detection alarm triggered by non-concerned targets to realize effective and accurate alarm.

Smart H.265+ & Smart H.264+

With advanced scene-adaptive rate control algorithm, Dahua smart encoding technology realizes the higher encoding efficiency than H.265 and H.264, provides high-quality video, and reduces the cost of storage and transmission.

Perimeter Protection

With deep learning algorithm, Dahua Perimeter Protection technology can recognize human and vehicle accurately. In restricted area (such as pedestrian area and vehicle area), the false alarms of intelligent detection based on target type (such as tripwire, intrusion) are largely reduced.

- 2MP, 1/2.8" CMOS image sensor, low illuminance, high image definition
- Outputs max. 2MP (1920 × 1080)@30 fps
- H.265 codec, high compression rate, low bit rate
- Built-in IR LED, max. IR distance: 60 m
- ROI, SMART H.264+/H.265+, flexible coding, applicable to various bandwidth and storage environments
- Rotation mode, WDR, 3D DNR, HLC, BLC, digital watermarking, applicable to various monitoring scenes
- Intelligent detection: Intrusion, tripwire (support the classification and accurate detection of vehicle and human)
- Abnormality detection: Motion detection, video tampering, scene changing, no SD card, SD card full, SD card error, network disconnection, IP conflict, illegal access, voltage detection
- Supports max. 256 G Micro SD card
- 12V DC/POE power supply
- IP67, IK10(optional) protection
- SMD Plus

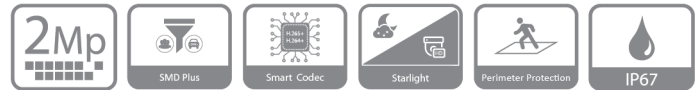

Starlight

Dahua Starlight technology mainly applies to the environment of low illumination, and it can provide clear colorful video. Even in the environment of min. illumination, the technology can guarantee the good image effect.

Cyber Security

Dahua network camera is equipped with a series of key security technologies, such as security authentication and authorization, access control, trusted protection, encrypted transmission, and encrypted storage, which improve its security defense and data protection, and prevent malicious programs from invading the device.

Protection (IP67, wide voltage)

IP67: The camera passes a series of strict test on dust and soak. It has dust-proof function, and the enclosure can works normal after soaking in 1 m deep water for 30 minutes.

Wide voltage: The camera allows $\pm 30\%$ input voltage tolerance (wide voltage range), and it is widely applied to outdoor environment with instable voltage.

Technical Specification

Camera

Image Sensor	1/2.8"2Megapixel progressive CMOS
Max. Resolution	1920 (H) x1080 (V)
ROM	128 MB
RAM	256 MB
Scanning System	Progressive
Electronic Shutter Speed	Auto/Manual 1/3 s-1/100000 s
Min. Illumination	0.002 Lux@F1.4 (Color, 30IRE) 0.0002 Lux@F1.4 (B/W, 30IRE) 0 Lux (Illuminator on)
S/N Ratio	> 56 dB
Illumination Distance	60 m (197 ft)
Illuminator On/Off Control	Auto/Manual
Illuminator Number	4 (IR LED)
Pan/Tilt/Rotation Range	Pan: 0°-360°; Tilt: 0°-90°; Rotation: 0°-360°

Lens

Lens Type	Motorized vari-focal				
Mount Type	φ14				
Focal Length	2.7 mm-13.5 mm				
Max. Aperture	F1.4				
Field of View	Horizontal: 108°-28° Vertical: 57°-16° Diagonal: 130°-33°				
Iris Type	Fixed				
Close Focus Distance	0.8 m (2.6 ft)				
DORI Distance	Lens	Detect	Observe	Recognize	Identify
	W	44.1 m (144.7 ft)	17.6 m (57.7 ft)	8.8 m (28.9 ft)	4.4 m (14.4 ft)
	T	153.1 m (502.3 ft)	61.2 m (200.8 ft)	30.6 m (82.9 ft)	15.3 m (50.2 ft)

Professional, Intelligent

Perimeter Protection	Tripwire; intrusion (Recognition of human and vehicle)
Intelligent Search	Work together with Smart NVR to perform refine intelligent search, event extraction and merging to event videos

Video

Video Compression	H.265; H.264; H.264H; H.264B; MJPEG(only supported by sub stream)
Smart Codec	Smart H.265+ / Smart H.264+
Video Frame Rate	Main stream (1920 x 1080@1-25/30 fps) sub stream(704 x 576@1-25 fps/704 x 480@1-30 fps) third stream(1280 x 720@1-25/30 fps)
Stream Capability	3 streams
Resolution	1080p (1920 x 1080); 1.3M (1280 x 960); 720p (1280 x 720); D1 (704 x 576/704 x 480); VGA (640 x 480); CIF (352 x 288/352 x 240)
Bit Rate Control	CBR/VBR

Video Bit Rate	H.264: 3 Kbps-8192 Kbps H.265: 3 Kbps-8192 Kbps
Day/Night	Auto(ICR)/Color/B/W
BLC	Yes
HLC	Yes
WDR	120 dB
White Balance	Auto/natural/street lamp/outdoor/manual/regional custom
Gain Control	Auto/Manual
Noise Reduction	3D DNR
Motion Detection	OFF/ON (4 areas, rectangular)
Region of Interest(Rol)	Yes (4 areas)
Smart Illumination	Yes
Image Rotation	0°/90°/180°/270° (Support 90°/270° with 1920 x 1080 resolution and lower.)
Mirror	Yes
Privacy Masking	4 areas

Alarm

Alarm Event	No SD card; SD card full; SD card error; less service time of SD card (smart card supports); network disconnection; IP conflict; illegal access; voltage detection; security exception; motion detection;scene changing; intensity change; tripwire; intrusion; SMD
-------------	---

Network

Network	RJ-45 (10/100 Base-T)
SDK and API	Yes
Protocol	IPv4; IPv6; HTTP; TCP; UDP; ARP; RTP; RTSP; RTCP; RTMP; SMTP; FTP; SFTP; DHCP; DNS; DDNS; QoS; UPnP; NTP; Multicast; ICMP; IGMP; NFS; PPPoE; SNMP
Cyber Security	Video encryption; firmware encryption; configuration encryption; Digest; WSSE; account lockout; security logs; IP/MAC filtering; generation and importing of X.509 certification; syslog; HTTPS; 802.1x; trusted boot; trusted execution; trusted upgrade
Interoperability	ONVIF(Profile S/Profile G/Profile T);CGI;P2P;Milestone; Genetec
Scene Self-adaptation (SSA)	Yes
User/Host	20 (Total bandwidth: 64 M)
Storage	FTP; SFTP; Micro SD Card (support max. 256 G); NAS
Browser	IE: IE8, IE9, IE11 Chrome Firefox
Management Software	Smart PSS, DSS, DMSS
Mobile Phone	IOS; Android

Certification

Certifications	CE-LVD: EN62368-1 CE-EMC: Electromagnetic Compatibility Directive 2014/30/EU FCC: 47 CFR FCC Part 15, Subpart B UL/CUL: UL60950-1 CAN/CSA C22.2 No.60950-1-07
----------------	--

Power

Power Supply	12V DC/PoE (802.3af)
Power Consumption	< 9.4W

Environment

Operating Conditions	-30°C to +60°C (-22°F to +140°F)/less than 95%
Storage Conditions	-40°C to +60°C (-40°F to +140°F)
Protection Grade	IP67

Structure

Casing	Metal
Dimensions	244.1 mm × 79.0 mm × 75.9 mm (9.6" × 3.1" × 3.0") (L × W × H)
Net Weight	820 g (1.8lb)
Gross Weight	1090 g (2.4lb)

Ordering Information

Type	Part Number	Description
2MP Camera	DH-IPC-HFW3241TP-ZS	2MP IR Vari-focal Bullet WizSense Network Camera, PAL
	DH-IPC-HFW3241TN-ZS	2MP IR Vari-focal Bullet WizSense Network Camera, NTSC
Accessories (optional)	PFA130-E	Junction Box
	PFA152-E	Pole Mount
	PFM321D	DC12V1A Power Adapter
	LR1002-1ET/1EC	Single-port Long Reach Ethernet Over Coax Extender
	PFM900-E	Integrated Mount Tester
	PFM114	TLC SD Card

Accessories

Optional:

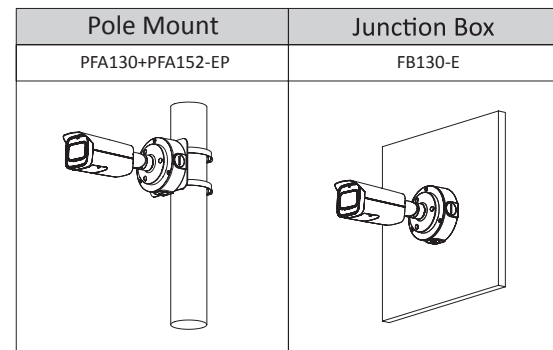

Dimensions (mm[inch])

