

LISTINO

# IT INFORMATION TECHNOLOGY

**NETWORK & TRANSMISSION  
MEMORY-VIDEOCONFERENCE**

# CONTENUTI

● NETWORK & TRANSMISSION .....	3
Switch PoE .....	4
Access Switch .....	20
Aggregation Switch .....	26
Core Switch .....	29
Router .....	30
Wireless Device .....	31
Accessori .....	37
● MEMORY .....	46
SSD Interni .....	47
SSD Portable .....	53
DRAM .....	54
Memory Card .....	55
Flash Drive USB .....	58
● VIDEOCONFERENCE .....	66
Telecamere - Webcam .....	67
Telecamere - All-in-Out .....	68
Telecamere PTZ / Speakerphone-Microfono Cablato .....	69
Speakerphone-Bluetooth / Cuffie con Microfono .....	70
Endpoint con PTZ / Endpoint Full-HD / Unità Multi-Controllo .....	71
Piattaforma Multi-Point .....	72



# NETWORK & TRANSMISSION



# Switch PoE

- PIÙ POTENZA E PROTEZIONE
- BT 90W (Red Port)
- Elevata protezione da sovratensioni
- Ampio range di temperatura di esercizio
  
- PORTATA TRASMISSIONE ESTESA
- PoE a lunga distanza
- Trasmissione PoE 8-wire
  
- GESTIONE PIÙ SMART
- PoE Watchdog
- Intelligent PoE
- Trasmissione video non-blocking

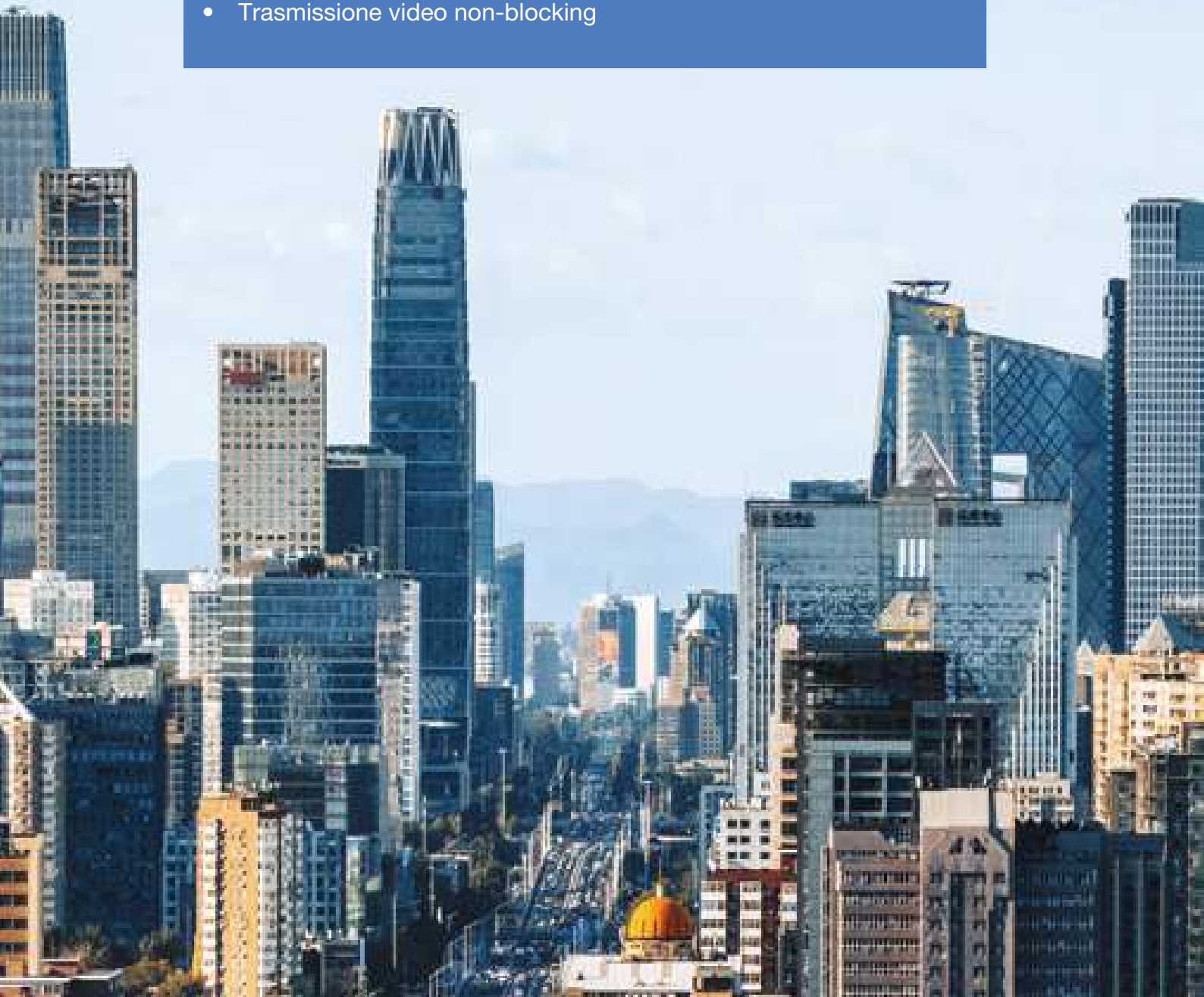

## Vantaggi

Gli switch PoE Dahua sono progettati per le telecamere IP a basso consumo. Le doppie porte uplink possono soddisfare le esigenze di collegamento in cascata, mentre funzioni come PoE watchdog, isolamento porte e trasmissione PoE fino a 250 metri rendono utilizzo e manutenzione ancora più pratici e sicuri.

## Highlights

### PoE intelligente

Monitora lo stato di alimentazione in tempo reale e garantisce il corretto funzionamento delle porte prioritarie.

### PoE a lunga distanza

La trasmissione PoE può raggiungere i 250 m (con banda delle porte PoE a 10 Mbps).



### PoE Watchdog

Lo switch monitora lo stato di alimentazione dei dispositivi collegati: se rileva un'anomalia, effettua in automatico il riavvio.

### Isolamento porte

Ogni porta è isolata dalle altre per sopprimere broadcast storm e ottimizzare le performance della rete.

## Scenari Applicativi



Catene retail



Condomini



Uffici



Ville

## DESKTOP

**PFS3005-4ET-60-V2**

M-0015974

**Prezzo € 50,00****PoE2.0****Caratteristiche**

Switch Layer 2 unmanaged con 5 porte (4 PoE 100 Mbps < 60 W + 1 uplink), capacità switching 1.8 Gbps, rate inoltro pacchetti 0.74 Mpps, orange port 60 W, PoE watchdog, trasmissione PoE fino a 250 m, 48~57 Vdc

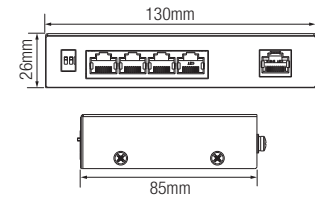
**Dimensioni****PFS3006-4ET-36**

M-0015379

**Prezzo € 50,00****Caratteristiche**

Switch unmanaged con 6 porte (4 PoE 100 Mbps < 36 W + 2 uplink), capacità switching 1.2 Gbps, rate inoltro pacchetti 0.89 Mpps, PoE watchdog, trasmissione PoE fino a 250 m, 100~240 Vac

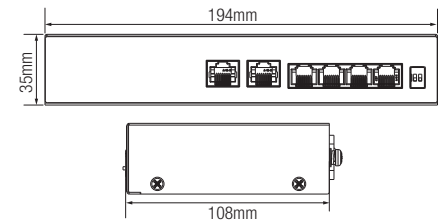
**Dimensioni****PFS3006-4ET-60-V2**

M-0015995

**Prezzo € 47,00****PoE2.0****Caratteristiche**

Switch Layer 2 unmanaged con 6 porte (4 PoE 100 Mbps < 60 W + 2 uplink), capacità switching 1.8 Gbps, rate inoltro pacchetti 0.89 Mpps, orange port 60 W, PoE watchdog, trasmissione PoE fino a 250 m, 53 Vdc, alimentatore incluso

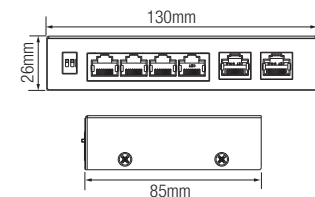
**Dimensioni****PFS3008-8ET-60-V2**

M-0018759

**Prezzo € 58,00****PoE2.0****Caratteristiche**

Switch unmanaged con 8 porte (4 PoE 100 Mbps < 60 W), capacità switching 1.8 Gbps, rate inoltro pacchetti 1.19 Mpps, orange port Hi-PoE 60 W, PoE watchdog, trasmissione PoE fino a 250 m, 48~57 Vdc

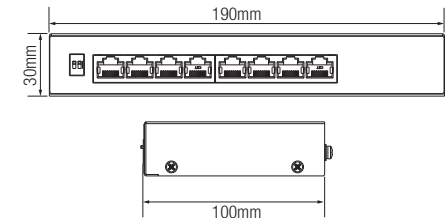
**Dimensioni****PFS3009-8ET-65**

M-0022989

**Prezzo € 61,00****Caratteristiche**

Switch Layer 2 unmanaged con 9 porte (8 PoE 10/100 Mbps < 65 W + 1 uplink), capacità switching 1.8 Gbps, rate inoltro pacchetti 1.339 Mpps, 100~240 Vac

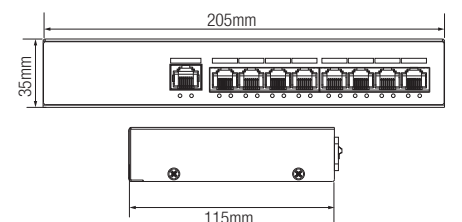
**Dimensioni**

## DESKTOP

**PFS3009-8ET-96-V2**

M-0020566

**Prezzo € 81,00**

**PoE2.0**



### Caratteristiche

Switch Layer 2 unmanaged con 9 porte (8 PoE 10/100 Mbps <96 W + 1 porta uplink), capacità switching 1.8 Gbps, rate inoltro pacchetti 1.34 Mpps, red port 90 W, PoE watchdog, trasmissione PoE fino a 250 m, case in metallo, 48~57 Vdc

### Dimensioni

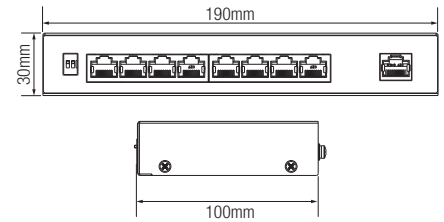

**PFS3009-8ET1GT-96-V2**

M-0018761

**Prezzo € 94,00**

**PoE2.0**



### Caratteristiche

Switch unmanaged con 9 porte (8 PoE 10/100 Mbps <96 W + 1 Gigabit uplink), capacità switching 3.6 Gbps, rate inoltro pacchetti 2.678 Mpps, red port 90 W, PoE watchdog, trasmissione PoE fino a 250 m, 48-57 Vdc

### Dimensioni

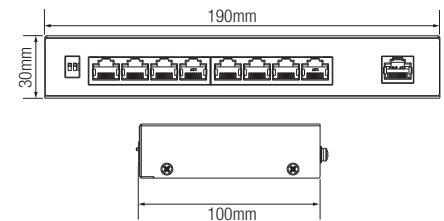

**PFS3010-8ET-65**

M-0015380

**Prezzo € 66,00**



### Caratteristiche

Switch unmanaged con 10 porte (8 PoE 10/100 Mbps <65 W + 2 uplink), capacità switching 2 Gbps, rate inoltro pacchetti 1.49 Mpps, PoE watchdog, trasmissione PoE fino a 250 m, 100-240 Vac

### Dimensioni

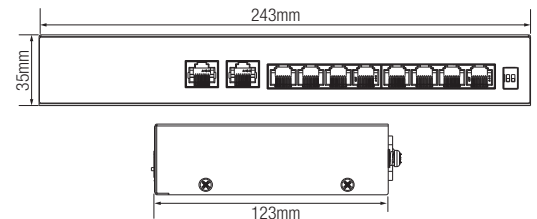

**PFS3010-8ET-96-V2**

M-0015997

**Prezzo € 83,00**

**PoE2.0**



### Caratteristiche

Switch unmanaged con 10 porte (8 PoE 100 Mbps <96 W + 2 uplink), capacità switching 5.6 Gbps, rate inoltro pacchetti 4.17 Mpps, red port BT 90 W, PoE watchdog, trasmissione PoE fino a 250 m, 48~57 Vdc

### Dimensioni

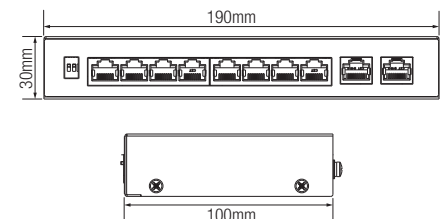

**PFS3110-8ET1GT1GF-96**

M-0026838

**Prezzo € 107,00**

**PoE2.0**



### Caratteristiche

Switch unmanaged con 10 porte (8 PoE 10/100 Mbps <96 W + 2 Gigabit uplink), capacità switching 5.6 Gbps, rate inoltro pacchetti 4.17 Mpps, red port BT 90 W, PoE watchdog, trasmissione PoE fino a 250 m, 53 Vdc, alimentatore incluso

### Dimensioni

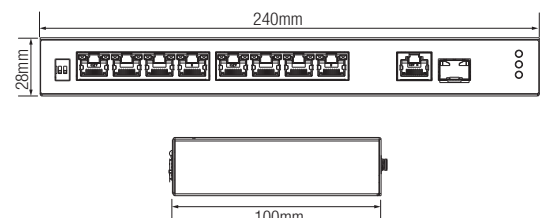

## DESKTOP

PFS3210-8ET2GF-96

M-0030207

Prezzo € 117,00

## PoE 2.0



## Caratteristiche

Switch unmanaged con 10 porte (8 Ethernet PoE <96 W + 2 combo uplink), capacità switching 5.6 Gbps, rate inoltra pacchetti 4.17 Mpps, red port BT 90 W, PoE watchdog, trasmissione PoE fino a 250 m, 53 Vdc, alimentatore incluso

## Dimensioni

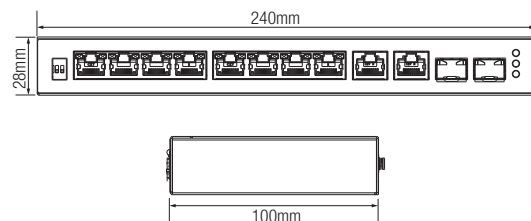

PFS3117-16ET-135

M-0009020

Prezzo € 214,00

## Caratteristiche



Switch Layer 2 unmanaged con 17 porte (16 PoE 10/100 Mbps <135 W + 1 Gigabit combo), capacità switching 5.2 Gbps, rate inoltra pacchetti 3.87 Mpps, 100~240 Vac

## Dimensioni

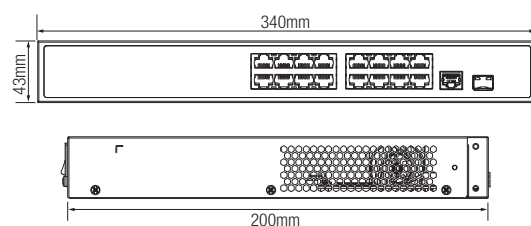

PFS3218-16ET-135

M-0015387

Prezzo € 176,00

## Caratteristiche



Switch Layer 2 unmanaged con 18 porte (16 Ethernet PoE 10/100 Mbps <135 W + 2 Gigabit combo (2 Ethernet / 2 SFP uplink)), capacità switching 7.2 Gbps, rate inoltra pacchetti 5.3568 Mpps, 100~240 Vac

## Dimensioni

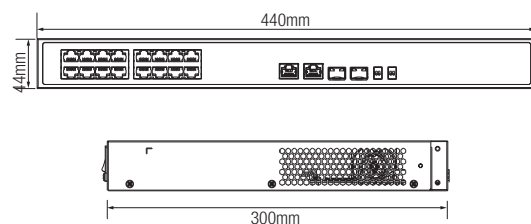

PFS3125-24ET-190

M-0009021

Prezzo € 274,00

## Caratteristiche



Switch Layer 2 unmanaged con 25 porte (24 PoE 10/100 Mbps <190 W + 1 Gigabit combo), capacità switching 6.8 Gbps, rate inoltra pacchetti 5.06 Mbps, 100~240 Vac

## Dimensioni

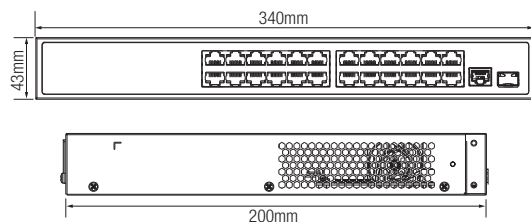

PFS3226-24ET-240

M-0015388

Prezzo € 227,00

## Caratteristiche



Switch Layer 2 unmanaged con 26 porte (24 Ethernet PoE 10/100 Mbps <240 W + 2 Gigabit combo (2 Ethernet / 2 SFP uplink)), capacità switching 8.8 Gbps, rate inoltra pacchetti 6.5472 Mpps, 100~240 Vac

## Dimensioni

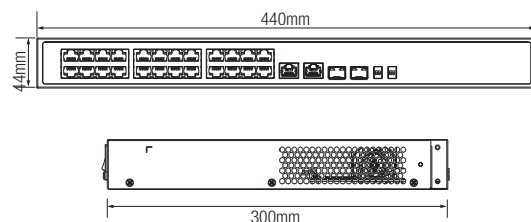



## DESKTOP

<b>PFS4218-16ET-190-V3</b>	M-0018768	<b>Prezzo € 265,00</b>
----------------------------	-----------	------------------------

### Caratteristiche

**PoE2+**



Switch Layer 2 managed con 18 porte (16 Ethernet PoE 10/100 Mbps <190 W + 2 Gigabit combo (2 Ethernet / 2 SFP uplink), capacità switching 8.8 Gbps, rate inoltra pacchetti 5.36 Mpps, red port BT 90 W, PoE watchdog, trasmissione PoE fino a 250 m, 100~240 Vac

### Dimensioni

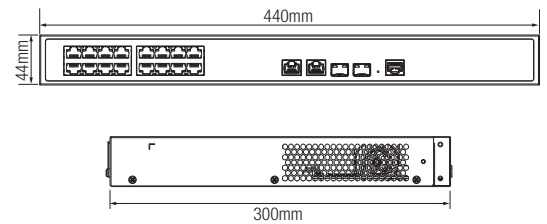

<b>PFS4218-16ET-240-V3</b>	M-0018769	<b>Prezzo € 282,00</b>
----------------------------	-----------	------------------------

### Caratteristiche

**PoE2+**



Switch Layer 2 managed con 18 porte (16 Ethernet PoE 10/100 Mbps <240 W + 2 Gigabit combo (2 Ethernet / 2 SFP uplink), capacità switching 8.8 Gbps, rate inoltra pacchetti 5.36 Mpps, red port BT 90 W, PoE watchdog, trasmissione PoE fino a 250 m, 100~240 Vac

### Dimensioni

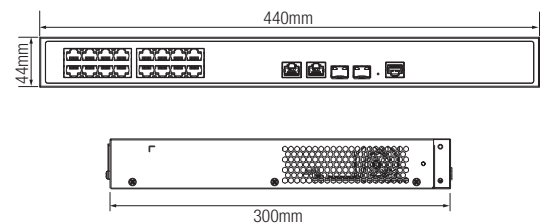

<b>PFS4226-24ET-240-V3</b>	M-0020237	<b>Prezzo € 298,00</b>
----------------------------	-----------	------------------------

### Caratteristiche

**PoE2+**



Switch Layer 2 managed con 26 porte (24 Ethernet PoE 10/100 Mbps <240 W + 2 Gigabit combo (2 Ethernet / 2 SFP uplink), capacità switching 8.8 Gbps, rate inoltra pacchetti 6.55 Mpps, red port BT 90 W, PoE watchdog, trasmissione PoE fino a 250 m, 100~240 Vac

### Dimensioni

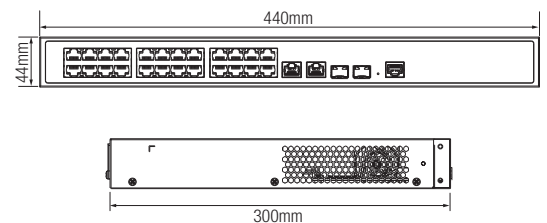

<b>PFS4226-24ET-360-V3</b>	M-0018772	<b>Prezzo € 362,00</b>
----------------------------	-----------	------------------------

### Caratteristiche

**PoE2+**



Switch Layer 2 managed con 26 porte (24 Ethernet PoE 10/100 Mbps <360 W + 2 Gigabit combo (2 Ethernet / 2 SFP uplink), capacità switching 8.8 Gbps, rate inoltra pacchetti 6.55 Mpps, red port BT 90 W, PoE watchdog, trasmissione PoE fino a 250 m, 100~240 Vac

### Dimensioni

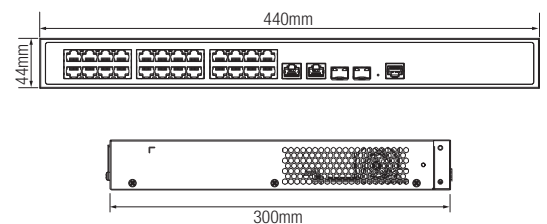

## WALL-MOUNTED

<b>PFS3111-8ET-96-F</b>	M-0013216	<b>Prezzo € 138,00</b>
-------------------------	-----------	------------------------

### Caratteristiche



Switch Layer 2 unmanaged con 11 porte (8 PoE 10/100 Mbps <96 W + 2 Gigabit uplink + 1 SFP uplink), capacità switching 13.6 Gbps, rate inoltra pacchetti 5.56 Mpps, 48~57 Vdc

### Dimensioni

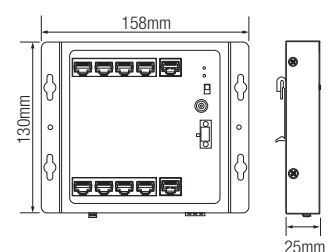

## ALL-GIGABIT PoE

PFS3005-4GT-36

M-0027716

Prezzo € 50,00



### Caratteristiche

Switch Layer 2 unmanaged con 5 porte (4 PoE Gigabit < 36 W + 1 uplink), capacità switching 10 Gbps, rate inoltra pacchetti 7.44 Mpps, 100~240 Vac, alimentatore incluso

### Dimensioni

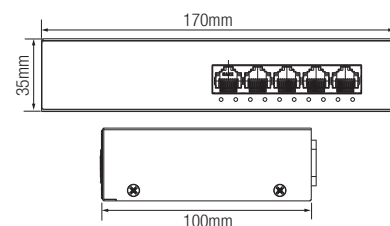

PFS3006-4GT-60-V2

M-0015977

Prezzo € 58,00

PoE 2.0



### Caratteristiche

Switch Layer 2 unmanaged con 6 porte Gigabit (4 PoE < 60 W + 2 uplink), capacità switching 14 Gbps, rate inoltra pacchetti 8.928 Mbps, orange port 60 W, PoE watchdog, trasmissione PoE fino a 250 m, 53 Vdc

### Dimensioni

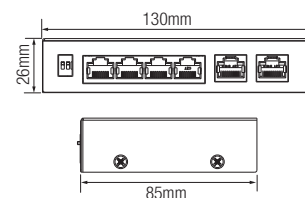

PFS3008-8GT-60-V2

M-0018760

Prezzo € 71,00

PoE 2.0



### Caratteristiche

Switch unmanaged con 8 porte Gigabit (4 PoE < 60 W), capacità switching 20 Gbps, rate inoltra pacchetti 11.9 Mpps, orange port Hi-PoE 60 W, PoE watchdog, trasmissione PoE fino a 250 m, 48~57 Vdc

### Dimensioni

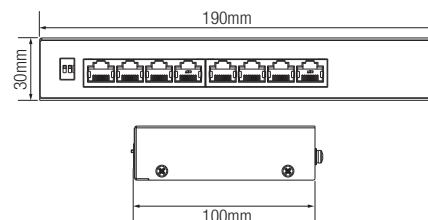

PFS3008-8GT-96-V2

M-0015979

Prezzo € 85,00

PoE 2.0



### Caratteristiche

Switch unmanaged con 8 porte Gigabit PoE < 96 W, capacità switching 20 Gbps, rate inoltra pacchetti 11.9 Mpps, red port 90 W, PoE watchdog, trasmissione PoE fino a 250 m, 48~57 Vdc

### Dimensioni

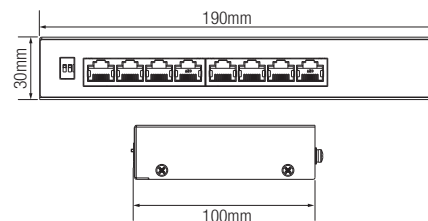

PFS3010-8GT-96-V2

M-0015980

Prezzo € 107,00

PoE 2.0



### Caratteristiche

Switch unmanaged con 10 porte Gigabit (8 PoE < 96 W + 2 uplink), capacità switching 20 Gbps, rate inoltra pacchetti 14.88 Mpps, red port BT 90 W, PoE watchdog, trasmissione PoE fino a 250 m, 48~57 Vdc

### Dimensioni

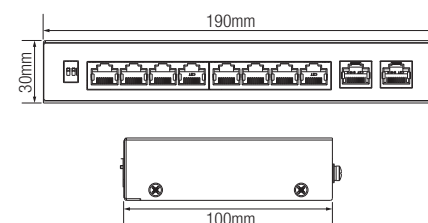

## ALL-GIGABIT PoE

**PFS3210-8GT2GF-96**

M-0027252

**Prezzo € 147,00**

**PoE2.0**



### Caratteristiche

Switch unmanaged con 10 porte Gigabit (8 Ethernet PoE <96 W + 2 combo uplink), capacità switching 20 Gbps, rate inoltro pacchetti 14.88 Mpps, red port 90 W, PoE watchdog, trasmissione PoE fino a 250 m, 53 Vdc, alimentatore incluso

### Dimensioni

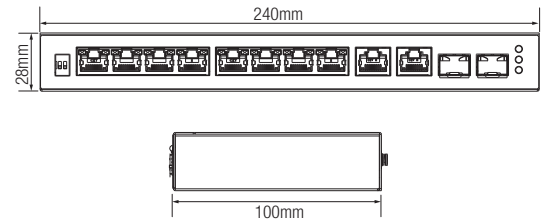

**PFS3016-16GT-190**

M-0018762

**Prezzo € 197,00**



### Caratteristiche

Switch unmanaged con 16 porte Gigabit PoE <190 W, capacità switching 32 Gbps, rate inoltro pacchetti 23.808 Mpps, orange port Hi-PoE 60 W, 48~57 Vdc

### Dimensioni

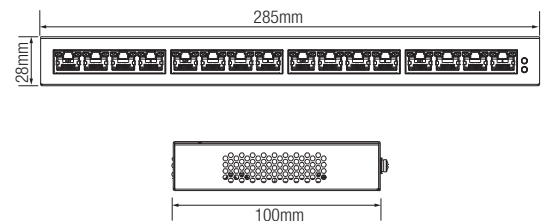

**PFS3110-8GT-65**

M-0028109

**Prezzo € 85,00**



### Caratteristiche

Switch Layer 2 unmanaged con 10 porte Gigabit (8 PoE <65 W), capacità switching 20 Gbps, rate inoltro pacchetti 14.88 Mpps, 100-240 Vac, alimentatore incluso

### Dimensioni

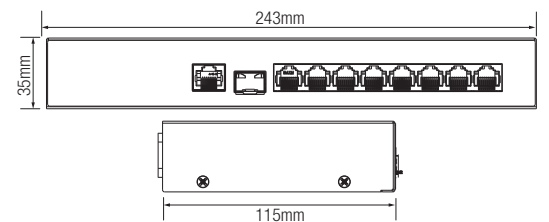

**PFS3218-16GT-135**

M-0029844

**Prezzo € 198,00**



### Caratteristiche

Switch Layer 2 unmanaged con 18 porte Gigabit (16 Ethernet PoE 10/100 Mbps <135 W + 2 SFP), capacità switching 36 Gbps, rate inoltro pacchetti 26.784 Mpps, 100~240 Vac, alimentatore incluso

### Dimensioni

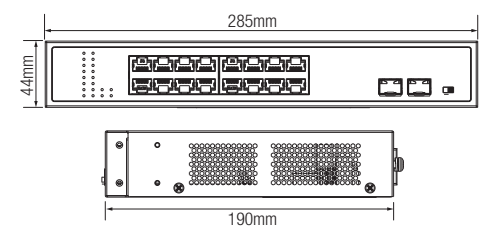

**PFS3220-16GT-190-V2**

M-0020174

**Prezzo € 289,00**



### Caratteristiche

Switch Layer 2 unmanaged con 20 porte Gigabit (18 RJ45 di cui 16 Ethernet PoE <190 W + 2 combo (2 Ethernet / 2 SFP uplink), capacità switching 52 Gbps, rate inoltro pacchetti 29.76 Mpps, 100~240 Vac

### Dimensioni

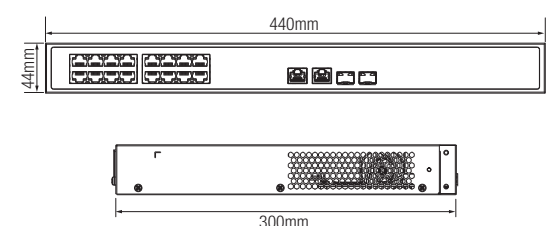

## ALL-GIGABIT PoE

PFS3220-16GT-240-V2

M-0020175

Prezzo € 334,00

■ Dimensioni



## ■ Caratteristiche

Switch Layer 2 unmanaged con 20 porte Gigabit (18 RJ45 di cui 16 Ethernet PoE <240 W + 2 combo (2 Ethernet / 2 SFP uplink), capacità switching 52 Gbps, rate inoltro pacchetti 29.76 Mpps, 100~240 Vac

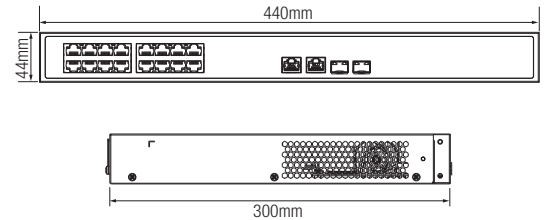

PFS3228-24GT-240-V2

M-0020176

Prezzo € 331,00

■ Dimensioni



## ■ Caratteristiche

Switch Layer 2 unmanaged con 28 porte Gigabit (26 RJ45 di cui 24 Ethernet PoE <240 W + 2 combo (2 Ethernet / 2 SFP uplink), capacità switching 52 Gbps, rate inoltro pacchetti 36.688 Mpps, 100~240 Vac

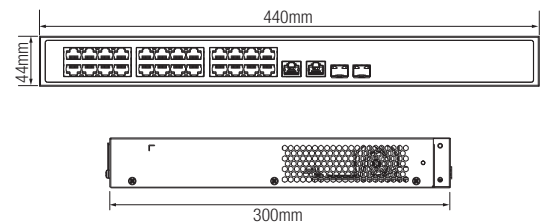

PFS3228-24GT-360-V2

M-0020177

Prezzo € 418,00

■ Dimensioni



## ■ Caratteristiche

Switch Layer 2 unmanaged con 28 porte Gigabit (26 RJ45 di cui 24 Ethernet PoE <360 W + 2 combo (2 Ethernet / 2 SFP uplink), capacità switching 52 Gbps, rate inoltro pacchetti 36.688 Mpps, 100~240 Vac

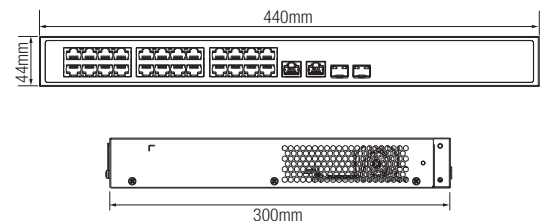

## ALL-GIGABIT PoE L2 MANAGED

PFS4210-8GT-150

M-0009033

Prezzo € 216,00

■ Dimensioni



## ■ Caratteristiche

Switch Layer 2 managed con 10 porte Ethernet (8 Gigabit PoE <150 W + 2 SFP), capacità switching 20 Gbps, rate inoltro pacchetti 14.88 Mpps, 100~240 Vac

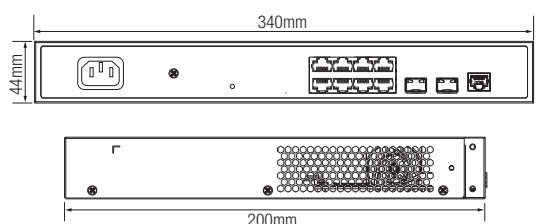

## ALL-GIGABIT PoE L2 MANAGED

**PFS4212-8GT-96**

M-0014430

**Prezzo € 215,00**

**PoE2+**



### Caratteristiche

Switch Layer 2 managed con 12 porte Gigabit (8 PoE <96 W), capacità switching 52 Gbps, rate inoltro pacchetti 17.856 Mpps, red port BT 90 W, PoE watchdog, trasmissione PoE fino a 250 m, 48-57 Vdc

### Dimensioni

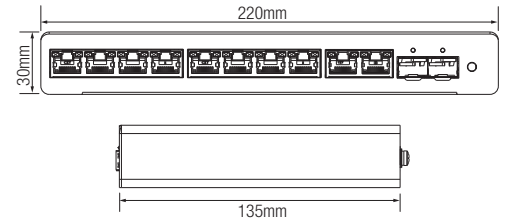

**PFS4212-8GT-110**

M-0022406

**Prezzo € 232,00**

**PoE2+**



### Caratteristiche

Switch Layer 2 managed con 12 porte Gigabit (8 PoE <110 W), capacità switching 52 Gbps, rate inoltro pacchetti 17.856 Mpps, red port BT 90 W, PoE watchdog, trasmissione PoE fino a 250 m, 48-57 Vdc

### Dimensioni

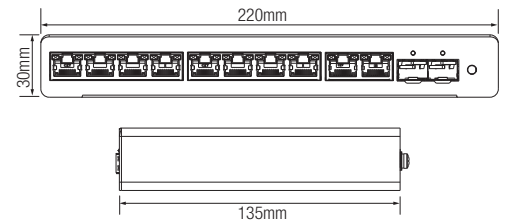

**PFS4420-16GT-240**

M-0015301

**Prezzo € 422,00**



### Caratteristiche

Switch Layer 2 managed con 20 porte Gigabit (16 Ethernet PoE <240 W + 4 Base-X), capacità switching 40 Gbps, rate inoltro pacchetti 29.76 Mpps, 100~240 Vac

### Dimensioni

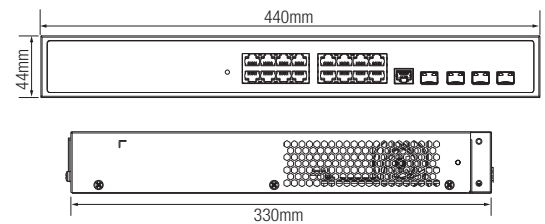

**PFS4218-16GT-130**

M-0030179

**Prezzo € 265,00**

**PoE2+**



### Caratteristiche

Switch Layer 2+ managed con 18 porte Gigabit (16 PoE <130 W), capacità switching 56 Gbps, rate inoltro pacchetti 29.76 Mpps, red port BT 90 W, PoE watchdog, trasmissione PoE fino a 250 m, 100-240 Vac, alimentatore incluso

### Dimensioni

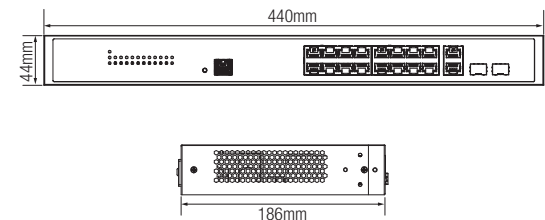

**PFS4218-16GT-190**

M-0009037

**Prezzo € 355,00**



### Caratteristiche

Switch Layer 2 managed con 18 porte Gigabit (16 PoE <190 W), capacità switching 52 Gbps, rate inoltro pacchetti 23.81 Mpps, orange port Hi-PoE 60 W, 100-240 Vac

### Dimensioni

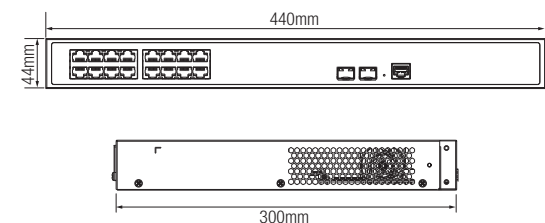

## ALL-GIGABIT PoE L2 MANAGED

PFS4218-16GT-230

M-0030180

Prezzo € 315,00

PoE 2.0



### Caratteristiche

Switch Layer 2+ managed con 18 porte Gigabit (16 PoE <230 W + 2 combo uplink), capacità switching 56 Gbps, rate inoltro pacchetti 29.76 Mpps, red port BT 90 W, PoE watchdog, trasmissione PoE fino a 250 m, 100-240 Vac, alimentatore incluso

### Dimensioni

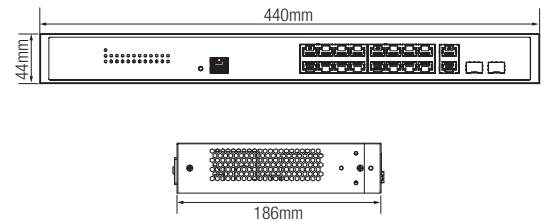

PFS4218-16GT-240

M-0009038

Prezzo € 383,00



### Caratteristiche

Switch Layer 2 managed con 18 porte Gigabit (16 PoE <240 W), capacità switching 52 Gbps, rate inoltro pacchetti 23.81 Mpps, orange port Hi-PoE 60 W, 100-240 Vac

### Dimensioni

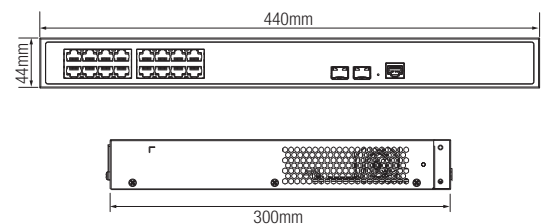

PFS4226-24GT-230

M-0030182

Prezzo € 400,00

PoE 2.0



### Caratteristiche

Switch Layer 2 managed con 26 porte Gigabit (24 Ethernet PoE <230 W + 2 SFP/uplink), capacità switching 56 Gbps, rate inoltro pacchetti 41.7 Mpps, red port BT 90 W, PoE watchdog, trasmissione PoE fino a 250 m, 100~240 Vac, alimentatore incluso

### Dimensioni

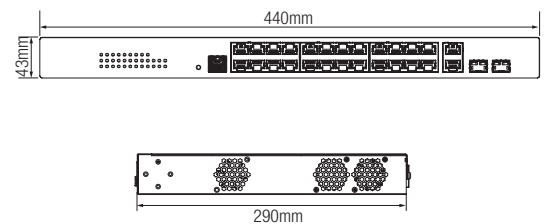

PFS4226-24GT-370

M-0030181

Prezzo € 481,00

PoE 2.0



### Caratteristiche

Switch Layer 2 managed con 26 porte Gigabit (24 Ethernet PoE <370 W + 2 SFP/uplink), capacità switching 56 Gbps, rate inoltro pacchetti 41.7 Mpps, red port BT 90 W, PoE watchdog, trasmissione PoE fino a 250 m, 100~240 Vac, alimentatore incluso

### Dimensioni

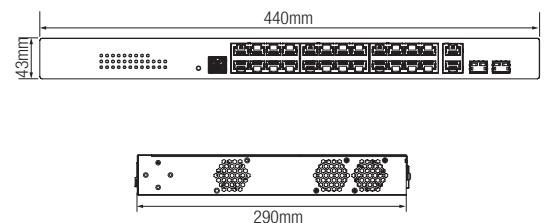

PFS4428-24GT-370

M-0009049

Prezzo € 556,00



### Caratteristiche

Switch Layer 2 managed con 28 porte Gigabit (24 Ethernet PoE <370 W + 4 Base-X), capacità switching 56 Gbps, rate inoltro pacchetti 41.66 Mpps, 100~240 Vac

### Dimensioni

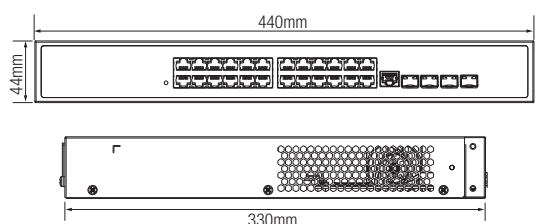

## ALL-GIGABIT PoE L3

**AS5500-8MGT2XF-370**

M-0028110

**Prezzo € 2.169,00**

**Dimensioni**



### Caratteristiche

Aggregation switch L3 managed con 8 porte Ethernet Gigabit (budget PoE <370 W)+ 2 uplink 10 Gbps, capacità switching 128 Gbps, rate inoltro pacchetti 95.232 Mpps

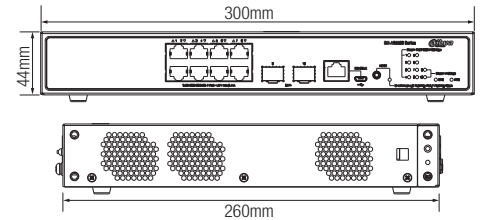

**AS5500-24MGT4XF-600**

M-0028111

**Prezzo € 3.699,00**

**Dimensioni**



### Caratteristiche

Aggregation switch PoE L3 managed con 24 porte Ethernet Gigabit (budget PoE <600 W)+ 4 SFP 10 Gbps, capacità switching 400 Gbps, rate inoltro pacchetti 240 Mpps, IRF2

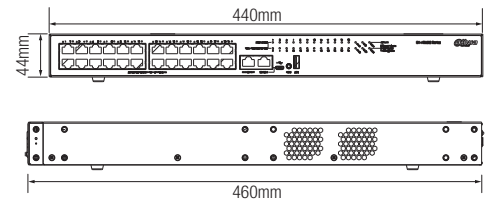

**AS5500-24GT4XF-370**

M-0021312

**Prezzo € 1.277,00**

**Dimensioni**



### Caratteristiche

Aggregation switch PoE L3 managed con 24 porte Ethernet Gigabit (budget PoE <370 W)+ 4 SFP 10 Gbps, capacità switching 128 Gbps, rate inoltro pacchetti 95.232 Mpps, 2 fan, alimentazione 100~240 Vac <451 W, alimentatore incluso

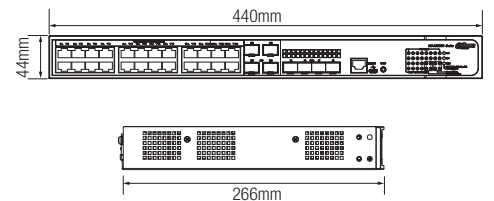

**AS5500-48GT4XF-600**

M-0028831

**Prezzo € 2.572,00**

**Dimensioni**



### Caratteristiche

Aggregation switch PoE L3 managed con 48 porte Ethernet Gigabit (budget PoE <600 W)+ 4 SFP 10 Gbps, capacità switching 176 Gbps, rate inoltro pacchetti 130.952 Mpps, IRF2, alimentazione integrata 100-240 Vac

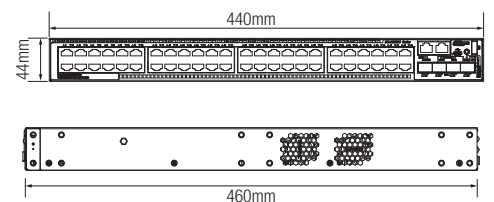

HARDENED

PFS3103-1GT1ET-60-V2

M-0018763

Prezzo € 80,00

PoE 2.0



### Caratteristiche

Switch hardened unmanaged 3 porte (2 PoE <60 W + 1 SFP uplink), capacità switching 7.6 Gbps, rate inoltro pacchetti 4.17 Mbps, orange port Hi-PoE 60 W, PoE watchdog, trasmissione PoE fino a 250 m, 48-57 Vdc

### Dimensioni

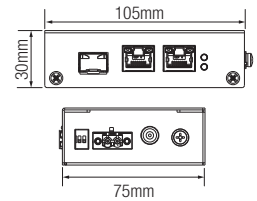

PFS3106-4ET-60-V2

M-0015998

Prezzo € 70,00

PoE 2.0



### Caratteristiche

Switch hardened unmanaged 6 porte (4 PoE 10/100 Mbps <60 W + 2 Gigabit uplink), capacità switching 6.8 Gbps, rate inoltro pacchetti 3.57 Mbps, orange port Hi-PoE 60 W, PoE watchdog, trasmissione PoE fino a 250 m, 53 Vdc

### Dimensioni

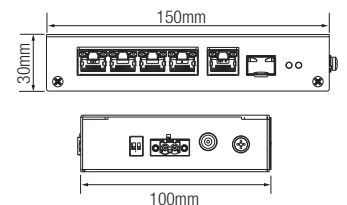

PFS4307-4ET-96

M-0027506

Prezzo € 117,00

PoE 2.0



### Caratteristiche

Switch L2 managed hardened con 7 porte (4 PoE 10/100 Mbps <96 W + 3 ottiche Gigabit uplink), capacità switching 6.8 Gbps, rate inoltro pacchetti 5.06 Mbps, PoE watchdog, trasmissione PoE fino a 250 m, montaggio desktop e DIN rail, 48~57 Vdc, alimentatore incluso

### Dimensioni

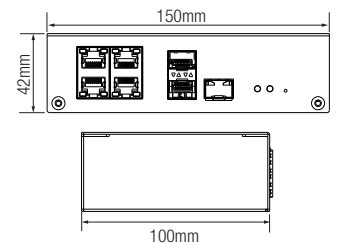

PFS3206-4P-96

M-0009022

Prezzo € 96,00



### Caratteristiche

Switch L2 managed con 6 porte (4 PoE <96 W + 2 SFP), capacità switching 6.8 Gbps, rate inoltro pacchetti 4.91 Mpps, 48~57 Vdc

### Dimensioni

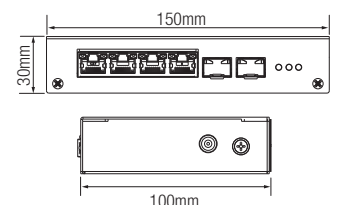

PFS3206-4P-120

M-0000447

Prezzo € 109,00



### Caratteristiche

Switch L2 unmanaged con 6 porte (4 PoE <120 W + 2 SFP), capacità switching 6.8 Gbps, rate inoltro pacchetti 4.91 Mpps, 48~57 Vdc

### Dimensioni

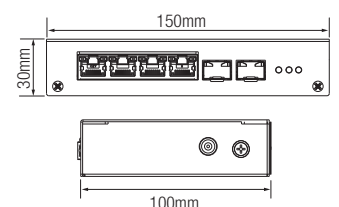



HARDENED

**PFS4206-4P-96**

M-0009032

**Prezzo € 114,00**



### Caratteristiche

Switch L2 managed con 6 porte (4 PoE <96 W di cui 1 Hi-PoE Gigabit + 2 SFP), capacità switching 6.8 Gbps, rate inoltro pacchetti 4.91 Mpps, 48~57 Vdc

### Dimensioni

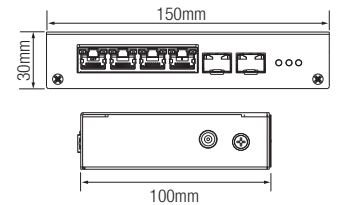

**PFS4206-4P-120**

M-0009031

**Prezzo € 134,00**



### Caratteristiche

Switch L2 managed con 6 porte (4 PoE <120 W di cui 1 Hi-PoE Gigabit + 2 SFP), capacità switching 6.8 Gbps, rate inoltro pacchetti 4.91 Mpps, 48~57 Vdc

### Dimensioni

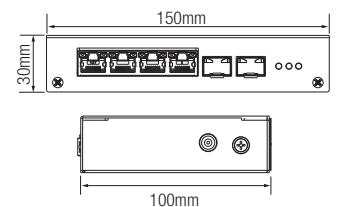

**PFS3110-8ET-96-V2**

M-0015999

**Prezzo € 103,00**

**PoE2.0**



### Caratteristiche

Switch hardened unmanaged con 10 porte (8 PoE 10/100 Mbps <96 W + 2 Gigabit uplink), capacità switching 7.6 Gbps, rate inoltro pacchetti 4.17 Mbps, red port BT 90 W, PoE watchdog, trasmissione PoE fino a 250 m, 48-57 Vdc

### Dimensioni

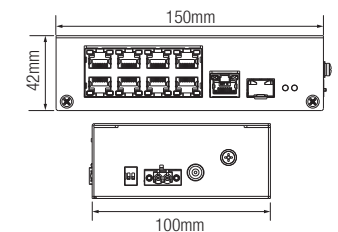

**PFS3409-4GT-96-V2**

M-0018765

**Prezzo € 158,00**

**PoE2.0**



### Caratteristiche

Switch hardened unmanaged con 9 porte Gigabit (4 PoE <96 W + 5 uplink), capacità switching 33 Gbps, rate inoltro pacchetti 13.39 Mpps, red port BT 90 W, PoE watchdog, trasmissione PoE fino a 250 m, 48-57 Vdc

### Dimensioni

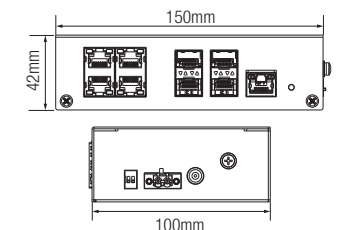

**PFS3211-8GT-120-V2**

M-0015984

**Prezzo € 213,00**

**PoE2.0**



### Caratteristiche

Switch hardened L2 unmanaged con 11 porte Gigabit (8 PoE <120 W + 2 uplink), capacità switching 33 Gbps, rate inoltro pacchetti 16.37 Mpps, red port BT 90 W, PoE watchdog, trasmissione PoE fino a 250 m, 48-57 Vdc

### Dimensioni

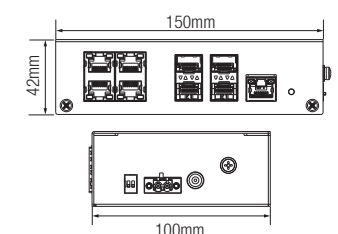

## INDUSTRIAL

PFS4410-6GT-DP-V2

M-0018774

Prezzo € 351,00

PoE2+



### Caratteristiche

Switch Industrial Layer 2 managed con 10 porte Gigabit (6 PoE <120 W), capacità switching 28 Gbps, rate inoltro pacchetti 14.88 Mpps, PoE watchdog, trasmissione PoE fino a 250 m, 48~57 Vdc, Din Rail

### Dimensioni

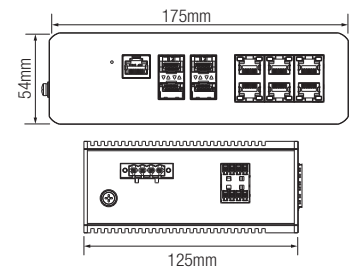

PFS4210-8GT-DP-V2

M-0018767

Prezzo € 371,00

PoE2+



### Caratteristiche

Switch Industrial Layer 2 managed con 10 porte Gigabit (8 PoE <120 W), capacità switching 28 Gbps, rate inoltro pacchetti 14.88 Mpps, 48~57 Vdc, Din Rail

### Dimensioni

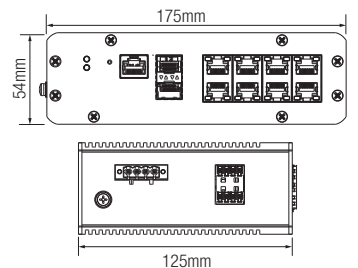

IS4204-2GT-120

M-0030546

Prezzo € 195,00

PoE2+



### Caratteristiche

Switch Industrial Layer 2 managed con 4 porte Gigabit (2 PoE <120 W), capacità switching 14 Gbps, rate inoltro pacchetti 5.95 Mpps, PoE watchdog, trasmissione PoE fino a 250 m, 48-57 Vdc, Din Rail, alimentatore NON incluso

### Dimensioni

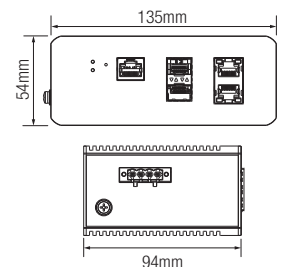

IS4207-4GT-120

M-0030548

Prezzo € 252,00

PoE2+



### Caratteristiche

Switch Industrial Layer 2 managed con 7 porte Gigabit (4 PoE <120 W), capacità switching 14 Gbps, rate inoltro pacchetti 10.42 Mpps, PoE watchdog, trasmissione PoE fino a 250 m, 53 Vdc, Din Rail, alimentatore NON incluso

### Dimensioni

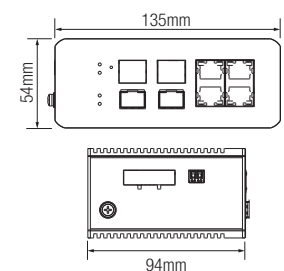

## ePoE

<b>LR2110-8ET-120</b>	M-0000357	<b>Prezzo € 188,00</b>
-----------------------	-----------	------------------------



### Caratteristiche

Switch Layer 2 unmanaged con 8 porte ePoE 10/100 Mbps <120 W, capacità switching 8.8 Gbps, rate inoltro pacchetti 4.17 Mpps, 48~57 Vdc

### Dimensioni

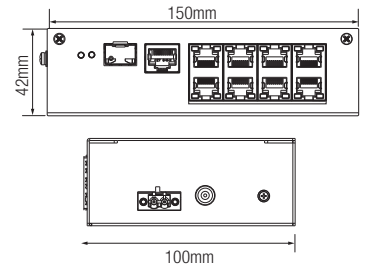

<b>LR2218-16ET-240-V2</b>	M-0020567	<b>Prezzo € 342,00</b>
---------------------------	-----------	------------------------



### Caratteristiche

Switch Layer 2 managed con 18 porte (16 Ethernet, 8 PoE <240 W e 8 ePoE 100 Mbps + 2 Gigabit combo (2 Ethernet / 2 SFP), capacità switching 8.8 Gbps, rate inoltro pacchetti 5.36 Mpps, 100~240 Vac

### Dimensioni

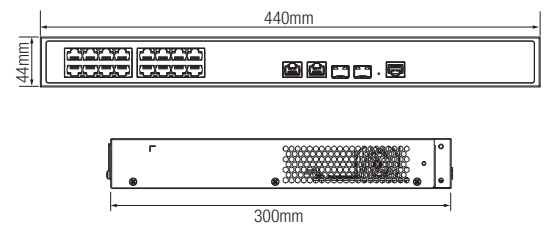

<b>LR2226-24ET-360-V2</b>	M-0020568	<b>Prezzo € 409,00</b>
---------------------------	-----------	------------------------



### Caratteristiche

Switch Layer 2 managed con 26 porte (24 Ethernet, 16 PoE <360 W e 8 ePoE 100 Mbps + 2 Gigabit combo (2 Ethernet / 2 SFP), capacità switching 8.8 Gbps, rate inoltro pacchetti 6.55 Mpps, 100~240 Vac

### Dimensioni

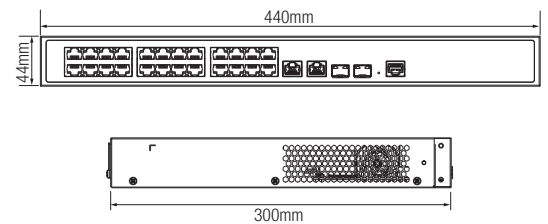

# Access Switch

- Access switch per TVCC IP
- Trasmissione video non-blocking
- Ampio range di temperatura di esercizio
- Protezione dalle sovratensioni elevata



## Vantaggi

### Plug & Play

Basta collegare lo switch all'alimentazione ed è subito operativo. È compatibile con qualsiasi dispositivo di rete: PC, telecamere IP, stampanti... Grazie all'Auto-MDI/MDIX non ci sono problemi con i cavi.

### Risparmio energetico

La tecnologia Energy Efficient Ethernet IEEE802.3az consente agli switch di regolare automaticamente il consumo energetico in base allo stato di collegamento e alla lunghezza del cavo, così da risparmiare energia e costi mantenendo performance eccellenti.

### Rete Fast/Gigabit affidabile

Attraverso le porte 10/100 e 10/10/1000 Mbps puoi espandere facilmente la tua rete domestica o aziendale connettendo molteplici dispositivi.

### Design compatto

La struttura di questi dispositivi è leggera e di dimensioni contenute, in modo da poterli installare ovunque in qualsiasi momento.

## Schema applicativo

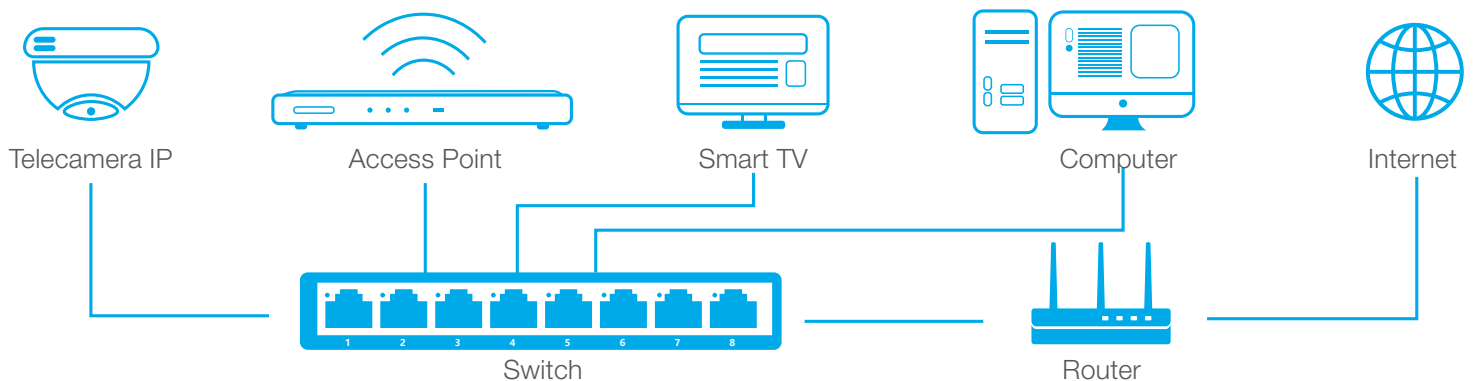

## Scenari



Abitazioni



Meeting Room



Esercizi commerciali

## PLASTIC

**PFS3005-5ET-L-V2**

M-0029621

**Prezzo € 8,00****Caratteristiche**

Switch Layer 2 unmanaged con 5 porte 100 Mbps, capacità switching 1 Gbps, rate inoltro pacchetti 0.744 Mpps, 5 Vdc, alimentatore incluso, case in plastica

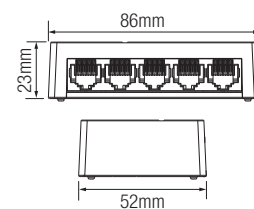
**Dimensioni****PFS3008-8ET-L-V2**

M-0029758

**Prezzo € 10,00****Caratteristiche**

Switch Layer 2 unmanaged con 8 porte 100 Mbps, capacità switching 1.6 Gbps, rate inoltro pacchetti 1.19 Mpps, 5 Vdc, case in plastica

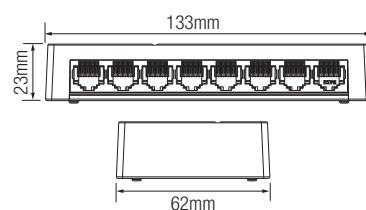
**Dimensioni****PFS3005-5GT-L-V2**

M-0029622

**Prezzo € 12,00****Caratteristiche**

Switch Layer 2 unmanaged con 5 porte Gigabit, capacità switching 10 Gbit, rate inoltro pacchetti 7.44 Mpps, 5 Vdc, alimentatore incluso, case in plastica

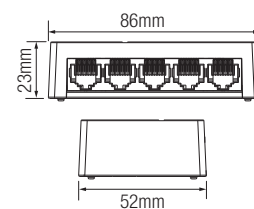
**Dimensioni****PFS3008-8GT-L-V2**

M-0030210

**Prezzo € 19,00****Caratteristiche**

Switch Layer 2 unmanaged con 8 porte Gigabit, capacità switching 16 Gbps, rate inoltro pacchetti 11.9 Mpps, 5 Vdc, alimentatore incluso, case in plastica

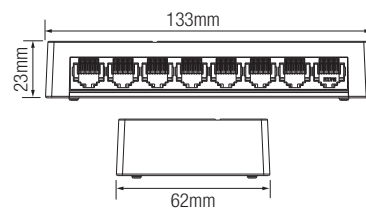
**Dimensioni****PFS3008-8GT-L**

M-0015378

**Prezzo € 23,00****Caratteristiche**

Switch Layer 2 unmanaged con 8 porte Gigabit, capacità switching 16 Gbps, rate inoltro pacchetti 11.9 Mpps, 5 Vdc, case in plastica

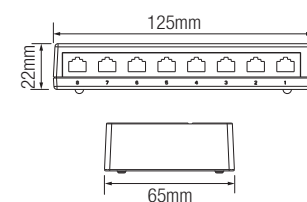
**Dimensioni**

METAL

**PFS3005-5ET-V2**

M-0029573

**Prezzo € 10,00**
**Dimensioni**

**Caratteristiche**

Switch Layer 2 unmanaged con 5 porte 100 Mbps, capacità switching 1 Gbit, rate inoltro pacchetti 0.744 Mpps, 5 Vdc, alimentatore incluso

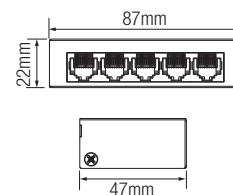

**PFS3008-8ET-V2**

M-0029572

**Prezzo € 12,00**
**Dimensioni**

**Caratteristiche**

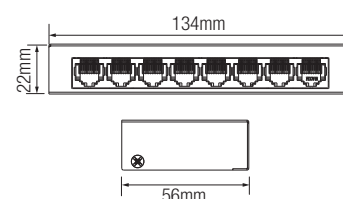
Switch Layer 2 unmanaged con 8 porte 100 Mbps, capacità switching 1.6 Gbit, rate inoltro pacchetti 1.1904 Mpps, 5 Vdc



**PFS3005-5GT-V2**

M-0015991

**Prezzo € 14,00**
**Dimensioni**

**Caratteristiche**

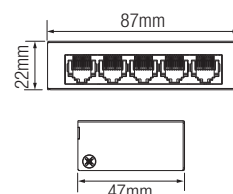
Switch Layer 2 unmanaged con 5 porte Gigabit, capacità switching 10 Gbit, rate inoltro pacchetti 7.44 Mpps, 5 Vdc, alimentatore incluso



**PFS3008-8GT-V2**

M-0015994

**Prezzo € 22,00**
**Dimensioni**

**Caratteristiche**

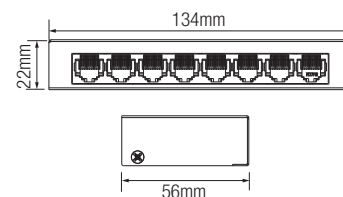
Switch Layer 2 unmanaged con 8 porte Gigabit, capacità switching 16 Gbit, rate inoltro pacchetti 11.904 Mpps, case in metallo, installazione desktop, 5 Vdc, alimentatore incluso



**PFS3016-16GT-M**

M-0022478

**Prezzo € 62,00**
**Dimensioni**

**Caratteristiche**

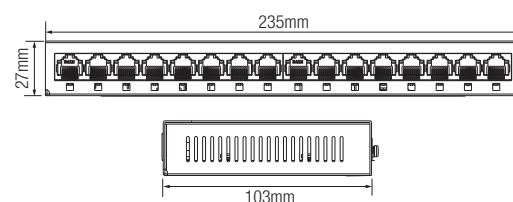
Switch Layer 2 unmanaged con 16 porte Gigabit Ethernet, capacità switching 32 Gbps, rate inoltro pacchetti 23.68 Mpps, case in metallo, 12 Vdc



## METAL

PFS3016-16GT

M-0009016

Prezzo € 80,00

■ Dimensioni



## ■ Caratteristiche

Switch Layer 2 unmanaged con 16 porte Gigabit, capacità switching 48 Gbps, rate inoltro pacchetti 35.721 Mpps, 100~240 Vac

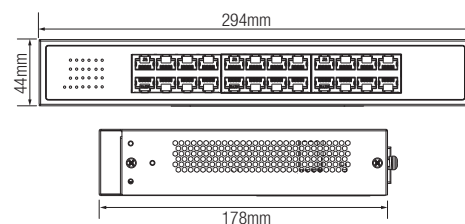

PFS3024-24GT

M-0009017

Prezzo € 106,00

■ Dimensioni



## ■ Caratteristiche

Switch Layer 2 unmanaged con 24 porte Gigabit, capacità switching 48 Gbps, rate inoltro pacchetti 35.7 Mpps, 100~240 Vac

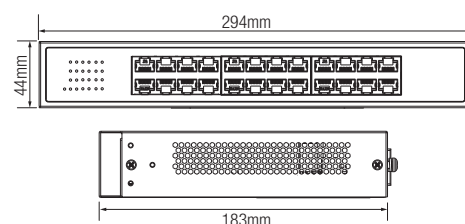

## HARDENED METAL

PFS3102-1T

M-0000443

Prezzo € 45,00

■ Dimensioni



## ■ Caratteristiche

Switch hardened L2 unmanaged 2 porte Gigabit (1 Ethernet + 1 SFP), capacità switching 6.8 G, rate inoltro pacchetti 2.98 Mpps, 12 Vdc

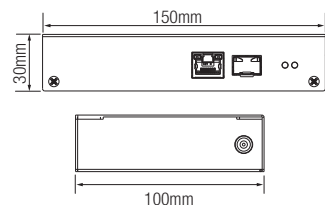

PFS3106-4T

M-0000445

Prezzo € 50,00

■ Dimensioni



## ■ Caratteristiche

Switch hardened L2 unmanaged 6 porte (4 Ethernet 10/100 Mbps + 2 Gigabit), capacità switching 6.8 G, rate inoltro pacchetti 3.57 Mpps, 12 Vdc

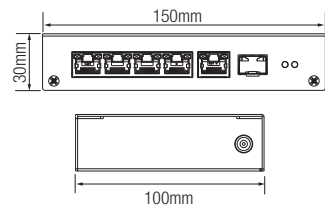

PFS3110-8T

M-0009019

Prezzo € 71,00

■ Dimensioni



## ■ Caratteristiche

Switch Layer 2 unmanaged con 10 porte (8 10/100 mbps + 1 Gigabit + 1 Gigabit SFP), capacità switching 13.6 Gbps, rate inoltro pacchetti 4.17 Mpps, 12 Vdc

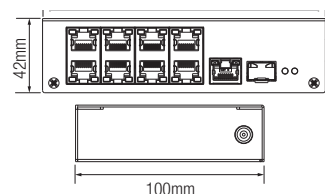



## HARDENED METAL

**PFS3409-4GT-V2**

M-0020178

**Prezzo € 125,00**

### Caratteristiche

Switch Layer 2 unmanaged 9 porte Gigabit Ethernet (4 SFP), capacità switching 33 Gbps, rate inoltro pacchetti 13.39 Mpps, 9~57 Vdc

### Dimensioni

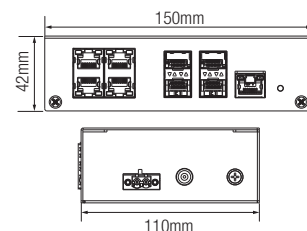
**PFS3211-8GT-V2**

M-0020179

**Prezzo € 143,00**

### Caratteristiche

Switch hardened Layer 2 unmanaged con 11 porte Gigabit (2 SFP), capacità switching 33 Gbps, rate inoltro pacchetti 16.37 Mpps, 9~57 Vdc

### Dimensioni

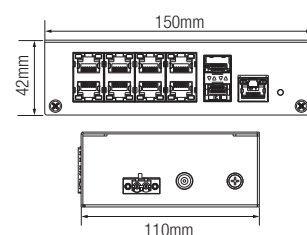

## ENTERPRISE

**AS4300-8GT2GF**

M-0030119

**Prezzo € 227,00**

### Caratteristiche

Access switch L2/L2+ managed con 8 porte Gigabit Ethernet + 2 SFP 100 Mbps/1 Gbps, capacità switching 20 Gbps, rate inoltro pacchetti 15 Mpps, IRF2, alimentatore incluso

### Dimensioni

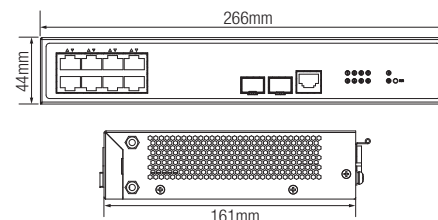
**AS4300-24GT4GF**

M-0030209

**Prezzo € 376,00**

### Caratteristiche

Access switch L2/L2+ managed con 24 porte Gigabit Ethernet + 4 SFP 100 Mbps/1 Gbps, capacità switching 56 Gbps, rate inoltro pacchetti 41.7 Mpps, IRF2, alimentatore incluso

### Dimensioni

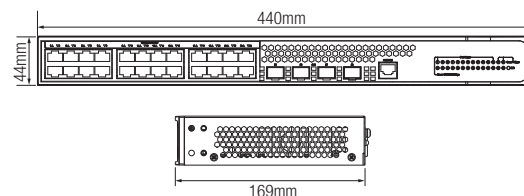
**AS4300-48GT4GF**

M-0030493

**Prezzo € 697,00**

### Caratteristiche

Access switch L2/L2+ managed con 48 porte Gigabit Ethernet + 4 SFP 100 Mbps/1 Gbps, capacità switching 104 Gbps, rate inoltro pacchetti 77.4 Mpps, IRF2, alimentatore incluso

### Dimensioni

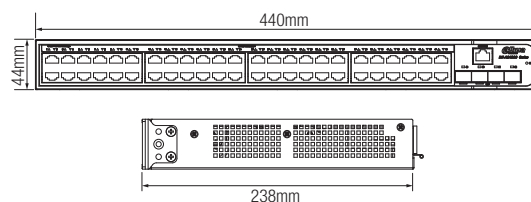

# Aggregation Switch

- L2+/L3 full gigabit switch
- Molteplici funzioni in un singolo device
- SFP+ 10-Gigabit
- La scelta ottimale per i sistemi TVCC IP



## L2+

**PFS5428-24GT-V2**

M-0018775

**Prezzo € 655,00**

**Dimensioni**



### Caratteristiche

Aggregation switch Layer 2+ managed con 24 porte Gigabit Base-T e 4 porte 1000/10000 Base-X SFP+, capacità switching 128 Gbps, rate inoltro pacchetti 96 Mpps, 100~240 Vac

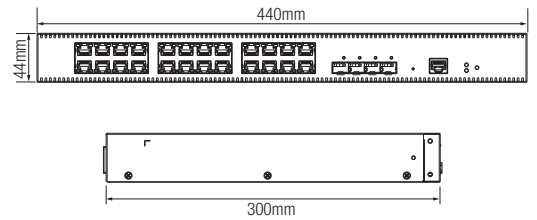

**PFS5936-24GF8GT4XF**

M-0014467

**Prezzo € 662,00**

**Dimensioni**



### Caratteristiche

Aggregation switch Layer 2+ managed con 36 porte Gigabit (24 fibra Base-X + 8 Ethernet Base-T + 4 1/10 Gbps SFP+), capacità switching 221 Gbps, rate inoltro pacchetti 107 Mpps, 100~240 Vac

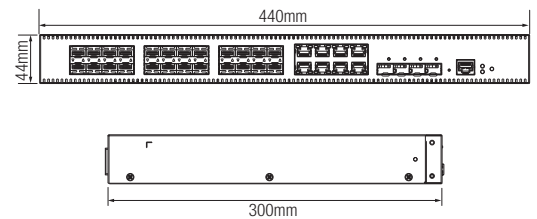

## L3

**AS5500-24GT4XF**

M-0020507

**Prezzo € 1.043,00**

**Dimensioni**



### Caratteristiche

Aggregation switch L3 managed con 24 porte Ethernet Gigabit + 4 SFP 1/10 Gbps, capacità switching 128 Gbps, rate inoltro pacchetti 95.232 Mpps, alimentatore incluso

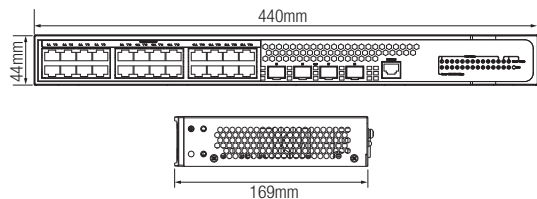

**AS5500-48GF4XF**

M-0030208

**Prezzo € 1.700,00**

**Dimensioni**



### Caratteristiche

Aggregation switch L3 managed con 48 porte Gigabit SFP (2 combo) + 4 SFP 1/10 Gbps, capacità switching 176 Gbps, rate inoltro pacchetti 130.952 Mpps, alimentatore incluso

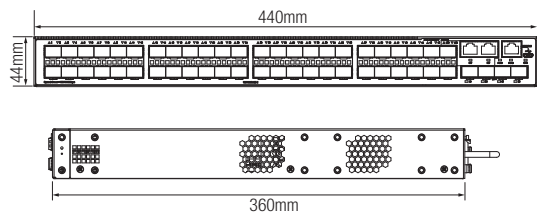

**S5500-48GT4XF-E-V2**

M-0030851

**Prezzo € 1.261,00**

**Dimensioni**



### Caratteristiche

Aggregation switch Layer 3 managed con 48 porte Ethernet Gigabit + 4 porte SFP+ 10 Gbps, capacità switching 176 Gbps, rate inoltro pacchetti 130.952 Mpps, 100~240 Vac <55 W, alimentatore incluso

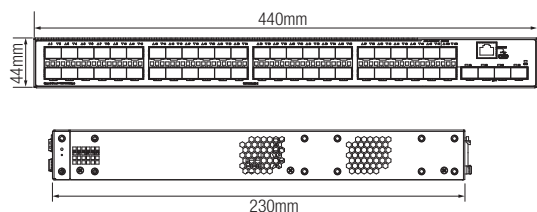

## ENHANCED L3

## AS5600-24GT4XF

M-0029931

Prezzo € 1.698,00

## Caratteristiche



Switch Layer 3 managed con 24 porte Gigabit ( 8 SFP combo / 4 SFP+ 10 Gbps), capacità switching 598 Gbps, rate inoltro pacchetti 168 Mpps, 100~240 Vac <33 W

## Dimensioni

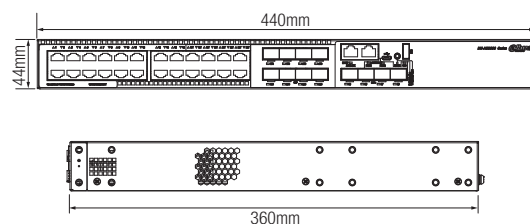

## S5600-48GT4XF

M-0015391

Prezzo € 2.113,00

## Caratteristiche



Aggregation switch Layer 3 managed con 48 porte Ethernet Gigabit + 4 porte ottiche 10 Gbps, capacità switching 598 Gbps, rate inoltro pacchetti 144 Mpps, 100~240 Vac <56 W

## Dimensioni

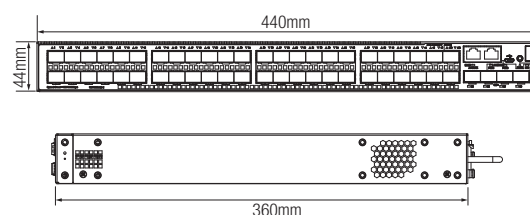

## AS5600-24GF4XF

M-0028828

Prezzo € 1.799,00

## Caratteristiche



Switch Layer 3 managed con 24 porte Gigabit (24 SFP / 8 Ethernet combo / 4 SFP+ uplink 10 Gbps), capacità switching 598 Gbps, rate inoltro pacchetti 128 Mpps, 100~240 Vac <45 W

## Dimensioni

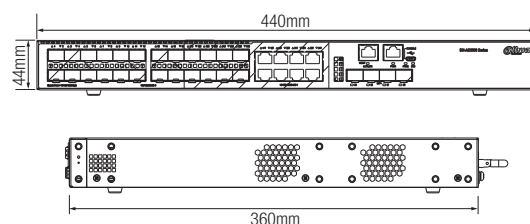

## AS5600-48GF4XF

M-0030161

Prezzo € 2.709,00

## Caratteristiche



Switch Layer 3 managed con 48 porte Gigabit SFP + 2 Gigabit Ethernet combo + 4 SFP+ 1/10 Gbps, capacità switching 598 Gbps, rate inoltro pacchetti 222 Mpps, alimentatore incluso

## Dimensioni

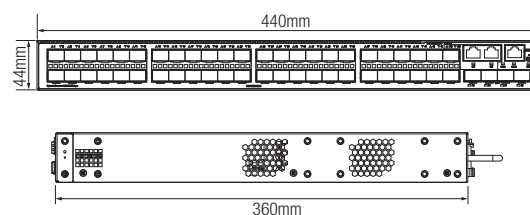

## AS6600-24XF2QF

M-0030103

Prezzo € 4.545,00

## Caratteristiche



Aggregation switch L3 managed con 24 porte Gigabit (SFP 10 Gbps + 2 QSFP 40 Gbps), capacità switching 2.56 Tbps, rate inoltro pacchetti 705 Mpps, 2 fan, doppia alimentazione 100~240 Vac <183 W

## Dimensioni

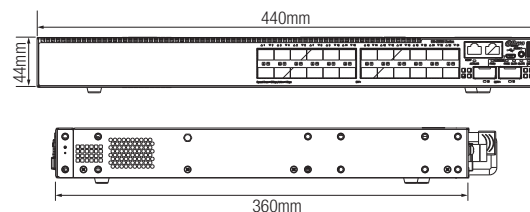

## S6500-48XF2QF-V2

M-0030852

Prezzo € 5.348,00

## Caratteristiche



Aggregation switch L3 managed con 48 porte Gigabit (SFP 10 Gbps + 2 QSFP 40 Gbps), capacità switching 1460 Gbps, rate inoltro pacchetti 1050 Mpps, 2 fan, doppia alimentazione 100~240 Vac <234 W, alimentatore incluso

## Dimensioni

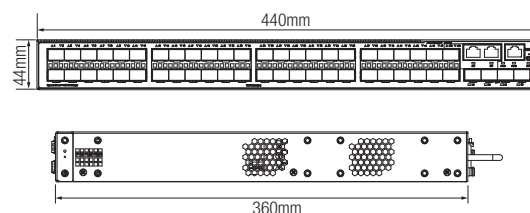

## CORE SWITCH

<b>S7803</b>	M-0030008	<b>Prezzo € 3.662,00</b>
--------------	-----------	--------------------------



### Caratteristiche

Core switch L3 managed, 5 slot (3 card + 2 MPU), Hot Swapping, 1 console port RJ45 + 1 micro USB, capacità switching 38.4 Tbps, rate inoltro pacchetti 7200 Mpps, IRF2, doppia alimentazione 100-240 Vac <490 W

<b>S7806</b>	M-0030750	<b>Prezzo € 5.957,00</b>
--------------	-----------	--------------------------



### Caratteristiche

Core switch L3 managed, 8 slot (6 card + 2 MPU), Hot Swapping, 1 console port RJ45 + 1 micro USB, capacità switching 76.8 Tbps, rate inoltro pacchetti 8640 Mpps, IRF2, doppia alimentazione 100-240 Vac <550 W

## MODULI ALIMENTAZIONE

<b>S7803-PWR300</b>	M-0030081	<b>Prezzo € 580,00</b>
---------------------	-----------	------------------------

Modulo alimentazione 300 W per core switch S7803

<b>S7806-PWR650</b>	M-0030853	<b>Prezzo € 640,00</b>
---------------------	-----------	------------------------

Modulo alimentazione 650 W per core switch S7806

## MASTER CONTROLLER

<b>S7803-MPU</b>	M-0030007	<b>Prezzo € 1.235,00</b>
------------------	-----------	--------------------------

Modulo master controller per core switch S7803

<b>S7806-MPU</b>	M-0030080	<b>Prezzo € 2.470,00</b>
------------------	-----------	--------------------------

Modulo master controller per core switch S7806

## MODULI PORTE

<b>S78-24GT8GF</b>	M-0030104	<b>Prezzo € 2.672,00</b>
--------------------	-----------	--------------------------

Modulo 24 porte RJ45 + 8 porte SFP per core switch

<b>S78-24GF8GT</b>	M-0030489	<b>Prezzo € 2.276,00</b>
--------------------	-----------	--------------------------

Modulo 24 porte SFP + 8 porte RJ45 per core switch S78

<b>S78-48GT</b>	M-0030801	<b>Prezzo € 2.682,00</b>
-----------------	-----------	--------------------------

Modulo 48 porte RJ45 per core switch S78

<b>S78-48GF</b>	M-0030778	<b>Prezzo € 2.266,00</b>
-----------------	-----------	--------------------------

Modulo 48 porte SFP per core switch S78

## MODULI PORTE

**S78-24GT20GF4XF**

M-0030490

**Prezzo € 3.692,00**

Modulo 24 porte RJ45 + 20 porte SFP + 4 porte SFP+ per core switch S78

**S78-16XF24GF**

M-0030800

**Prezzo € 5.295,00**

Modulo 16 porte SFP+ + 24 porte SFP per core switch S78

## PLATFORM

**ILS1000**

M-0016031

**Prezzo € 221,00**

### Caratteristiche

iLinksView Network Management Platform

### Dimensioni

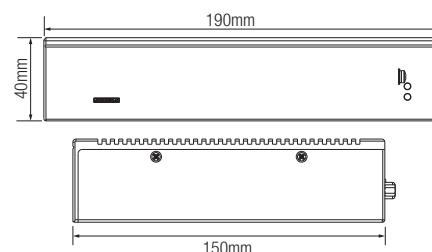

## ROUTER

## ENTERPRISE

**AR306-E**

M-0030111

**Prezzo € 346,00**

### Caratteristiche

Router L3 managed, 2 porte WAN, 4 porte LAN, 2 porte USB 2.0, 1 porta console, forwarding 200 Mbps, IPSec VPN, SSL VPN, L2TP VPN, MPLS, alimentazione integrata 100-240 Vac

### Dimensioni

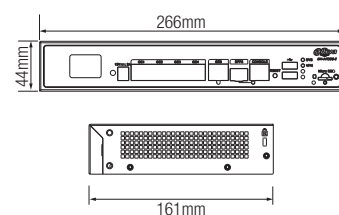
**AR506-E**

M-0030112

**Prezzo € 857,00**

### Caratteristiche

Router L3 managed, 2 porte WAN, 4 porte LAN, 2 porte USB 2.0, 1 porta console, forwarding 800 Mbps, IPSec VPN, SSL VPN, L2TP VPN, MPLS, alimentazione integrata 100-240 Vac

### Dimensioni

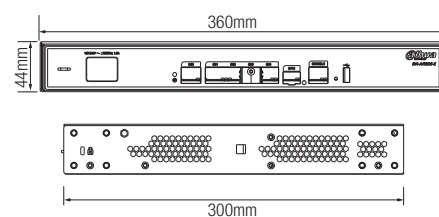

# Wireless Device

- Applicazioni Point-to-Point, Point-to-Multi-point, Back-to-Back
- La tecnologia TDMA garantisce l'affidabilità del sistema
- Installazione e configurazione semplici
- Multi-lingua
- Piattaforma di gestione gratuita DWMS



## V-RADIO

<b>PFWB5-30n</b>	M-0000460	<b>Prezzo € 79,00</b>
------------------	-----------	-----------------------



#### Caratteristiche

CPE ponte radio Wi-Fi 5G da esterno IP66, portata ottimale 3 km, frequenza operativa 5150~5850 GHz, 300 Mbps, antenna 15 dBi, standard WLAN a/n, 1 porta Ethernet, alimentazione da PoE passivo 12/24 Vdc/100~240 Vac <4.5 W

<b>PFWB5-10n</b>	M-0000458	<b>Prezzo € 112,00</b>
------------------	-----------	------------------------



#### Caratteristiche

CPE ponte radio Wi-Fi 5G da esterno IP66, portata ottimale 5 km, frequenza operativa 5150~5850 GHz, 300 Mbps, antenna 20 dBi, standard WLAN a/n, 1 porta Ethernet, alimentazione da PoE passivo 12/24 Vdc/100~240 Vac <4.5 W

<b>PFWB5-30ac</b>	M-0000459	<b>Prezzo € 140,00</b>
-------------------	-----------	------------------------



#### Caratteristiche

CPE ponte radio Wi-Fi 5G da esterno IP66, portata ottimale 3 km, frequenza operativa 5150~5850 GHz, 867 Mbps, antenna 15 dBi, standard WLAN a/n/ac, 1 porta Gigabit Ethernet, alimentazione da PoE passivo 12/24 Vdc/100~240 Vac <10 W

<b>PFWB5-10ac</b>	M-0000457	<b>Prezzo € 181,00</b>
-------------------	-----------	------------------------



#### Caratteristiche

CPE ponte radio Wi-Fi 5G da esterno IP66, portata ottimale 5 km, frequenza operativa 5150~5850 GHz, 867 Mbps, antenna 20 dBi, standard WLAN a/n/ac, 1 porta Gigabit Ethernet, alimentazione da PoE passivo 12/24 Vdc/100~240 Vac <10 W

## OUTDOOR

<b>PFM881</b>	M-0002605	<b>Prezzo € 156,00</b>
---------------	-----------	------------------------



#### Caratteristiche

CPE trasmettitore Wi-Fi 5G, portata ottimale 3 km, frequenza operativa 5745~5825 MHz, 300 Mbps, antenna interna 15 dBi, 1 porta Ethernet RJ45, alimentazione da iniettore PoE passivo <8 W

<b>PFM881E</b>	M-0002606	<b>Prezzo € 400,00</b>
----------------	-----------	------------------------



#### Caratteristiche

CPE trasmettitore Wi-Fi 5G, portata ottimale 3 km, frequenza operativa 5745~5825 MHz, 867 Mbps, antenna 18 dBi (direzionale), 2 porte Gigabit Ethernet, <25 W

## BASE STATION

## V-RADIO

<b>PFWB5-90n</b>	M-0000462	<b>Prezzo € 194,00</b>
------------------	-----------	------------------------



#### Caratteristiche

Base station ponte radio Wi-Fi 5G da esterno IP66, portata ottimale 3 km, frequenza operativa 5150~5850 GHz, 300 Mbps, antenna 18 dBi, standard WLAN a/n, 1 porta Ethernet, alimentazione da PoE passivo 12/24 Vdc/100~240 Vac <4.5 W

<b>PFWB5-90ac</b>	M-0000461	<b>Prezzo € 216,00</b>
-------------------	-----------	------------------------



#### Caratteristiche

Base station ponte radio Wi-Fi 5G da esterno IP66, portata ottimale 3 km, frequenza operativa 5150~5850 GHz, 867 Mbps, antenna 18 dBi, standard WLAN a/n/ac, 1 porta Gigabit Ethernet, alimentazione da PoE passivo 12/24 Vdc/100~240 Vac <10 W



## OUTDOOR

**PFM880** M-0002601 **Prezzo € 587,00**



### Caratteristiche

Access Point Wi-Fi 5G da esterno IP66, portata massima 3 km, frequenza operativa 5745~5825 MHz, 300 Mbps, antenna 16 dBi, 1 porta Gigabit Ethernet, alimentazione PoE+ da iniettore <15 W

**PFM880E** M-0002603 **Prezzo € 685,00**



### Caratteristiche

Access Point Wi-Fi 5G da esterno IP66, portata massima 3 km, frequenza operativa 5745~5825 MHz, 867 Mbps, antenna 17 dBi, 1 porta Gigabit Ethernet, alimentazione PoE+ da iniettore <15 W

## INDOOR

**PFM889-I** M-0002613 **Prezzo € 65,00**



### Caratteristiche

Access point Wi-Fi 2.4G da interno IP41, portata massima 150 m, frequenza operativa 2412~2472, 300 Mbps, antenna 3 dBi, 1 porta Gigabit Ethernet, alimentazione PoE+ da iniettore/12 Vdc <8 W

**PFM885-I** M-0002607 **Prezzo € 172,00**



### Caratteristiche

Access point Wi-Fi 2.4G da interno IP41 per ascensori, portata massima 500 m, frequenza operativa 2412~2472, 300 Mbps, antenna 6 dBi, 2 porte Ethernet, alimentazione PoE+ da iniettore/12 Vdc <8 W

*(per ascensori)*

**EAP5212-C** M-0030454 **Prezzo € 59,00**



### Caratteristiche

Access point wireless 5 (802.11a/n/ac) 2.4/5.8 G, MU-MIMO, potenza trasmissione <20 dBm, guadagno antenna <2.4 dBi

**EAP6218-C** M-0030382 **Prezzo € 83,00**



### Caratteristiche

Access point wireless 6 (802.11a/n/ac/ax) 2.4/5.8 G, MU-MIMO, guadagno antenna <4 dBi

## WI-FI 6

AWA6220-C M-0028829 Prezzo € 251,00



## ■ Caratteristiche

Access point wireless (802.11a/b/g/n/ac/ax) 2.4/5G da interno IP41, access rate 1.775 Gbps, DL/UL MU-MIMO, potenza trasmissione <20 dBm, guadagno antenne <5 dBi

AWA6330-C M-0029777 Prezzo € 504,00



## ■ Caratteristiche

Access point wireless (802.11ax) 2.4/5G da interno IP42, access rate 3.267 Gbps, DL/UL MU-MIMO, potenza trasmissione <20 dBm, guadagno antenne <5 dBi

AWA6220-W M-0030305 Prezzo € 252,00



## ■ Caratteristiche

Access point wireless (802.11a/b/g/n/ac/ax) 2.4/5G da interno IP31, access rate 1.775 Gbps, DL/UL MU-MIMO, potenza trasmissione <20 dBm, guadagno antenne <5 dBi, installazione a parete

AWA6220-O M-0030417 Prezzo € 960,00



## ■ Caratteristiche

Access point wireless (802.11a/b/g/n/ac/ax) 2.4/5G da esterno IP68, DL/UL MU-MIMO, potenza trasmissione <24 dBm, guadagno antenne <5 dBi

## ACCESSORI

PFA15A M-0014399 Prezzo € 35,00



## ■ Caratteristiche

Staffa access point Wi-fi

## BACKHAUL 5G

## OUTDOOR

PFM886-15 M-0002609 Prezzo € 294,00



## ■ Caratteristiche

Backhaul Wi-Fi 5G da esterno IP66, portata massima 15 km, frequenza operativa 5745~5825 MHz, 867 Mbps, antenna 23 dBi, 1 porta Gigabit Ethernet, alimentazione PoE+ da iniettore <25 W

## ENTERPRISE WI-FI

<b>AC10</b>	M-0028832	<b>Prezzo € 662,00</b>
-------------	-----------	------------------------

### Dimensioni



### Caratteristiche

Access control wireless con 10 porte PoE+ Gigabit, 2 porte WAN Gigabit, 1 porta USB, NAT, out PoE, PoE+, forwarding 800 Mbps, max AP gestiti 10, 100~240 Vac

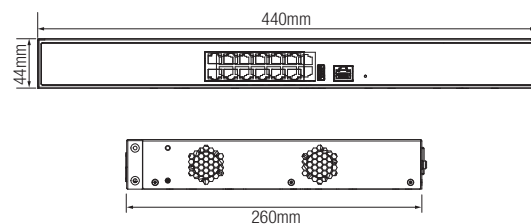

<b>AC64</b>	M-0029776	<b>Prezzo € 1.665,00</b>
-------------	-----------	--------------------------

### Dimensioni



### Caratteristiche

Access control wireless con 10 porte Gigabit Ethernet (2 10 GE SFP+), 2 porte WAN 2.5 Gigabit, 1 porta USB, NAT, forwarding 4 Gbps, max. AP gestiti 64, 100~240 Vac

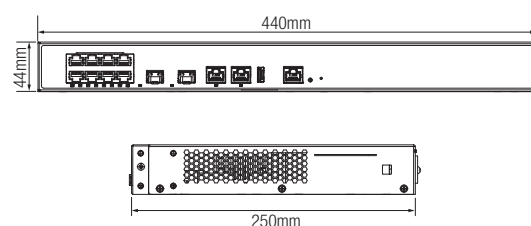

# PONTI RADIO WIRELESS

## OUTDOOR

<b>WBC5-45AC-03P</b>	M-0029690	<b>Prezzo € 120,00</b>
----------------------	-----------	------------------------

### Dimensioni



### Caratteristiche

Ponte radio Wi-Fi 2.4/5G da esterno IP65, portata ottimale 3 km, 867 Mbps, guadagno antenna 12 dBi, 802.11a/b/g/n/ac, 1 porta Gigabit PoE, 1 porta LAN 100 Mbps, alimentazione PoE

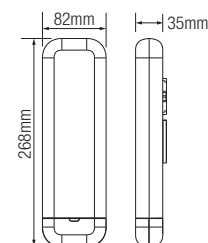

<b>WBC5-30AC-05P</b>	M-0029689	<b>Prezzo € 187,00</b>
----------------------	-----------	------------------------

### Dimensioni



### Caratteristiche

Ponte radio Wi-Fi 2.4/5G da esterno IP65, portata ottimale 5 km, 867 Mbps, guadagno antenna 12 dBi, 802.11a/n/ac, 1 porta Gigabit PoE, 1 porta LAN 100 Mbps, alimentazione PoE

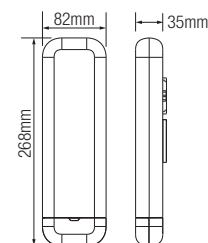

<b>WB2-60N-I</b>	M-0030077	<b>Prezzo € 96,00</b>
------------------	-----------	-----------------------

### Dimensioni



(per ascensori)

### Caratteristiche

Ponte radio wireless 2.4GHz da esterno IP65, IEEE802.11b/g/n, guadagno antenne 8 dBi, 1 porta LAN, 1 porta WAN, canali 1~13, WPA2 alimentazione PoE

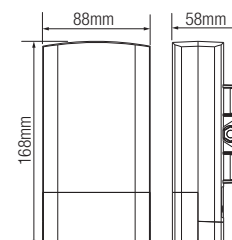

## PROFESSIONAL

**WM4700-0**

M-0015078

**Prezzo € 218,00**
**Dimensioni**

**Caratteristiche**

Modem router 4G Wi-Fi professionale, 100 Mbps in download e 50 Mbps in upload, VPN, mappatura porte, memoria 128 MB, 1 porta WAN 100 Mbps, 4 porte LAN 100 Mbps, 1 porta seriale RS232, slot SIM/UIM, indicatori stato, 12 Vdc <6.6 W

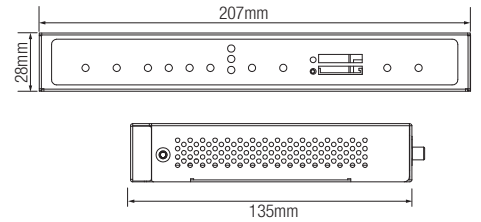

# ROUTER

## HOME WI-FI

**WR5210-IDC**

M-0019859

**Prezzo € 41,00**
**Dimensioni**

**Caratteristiche**

Router wireless dual-band 5/2.4 GHz, 1 porta WAN 1000 Mbps, 3 porte LAN 1000 Mbps, 128 MB RAM, portata trasmissione 150 m (in campo aperto), 12 Vdc <12 W

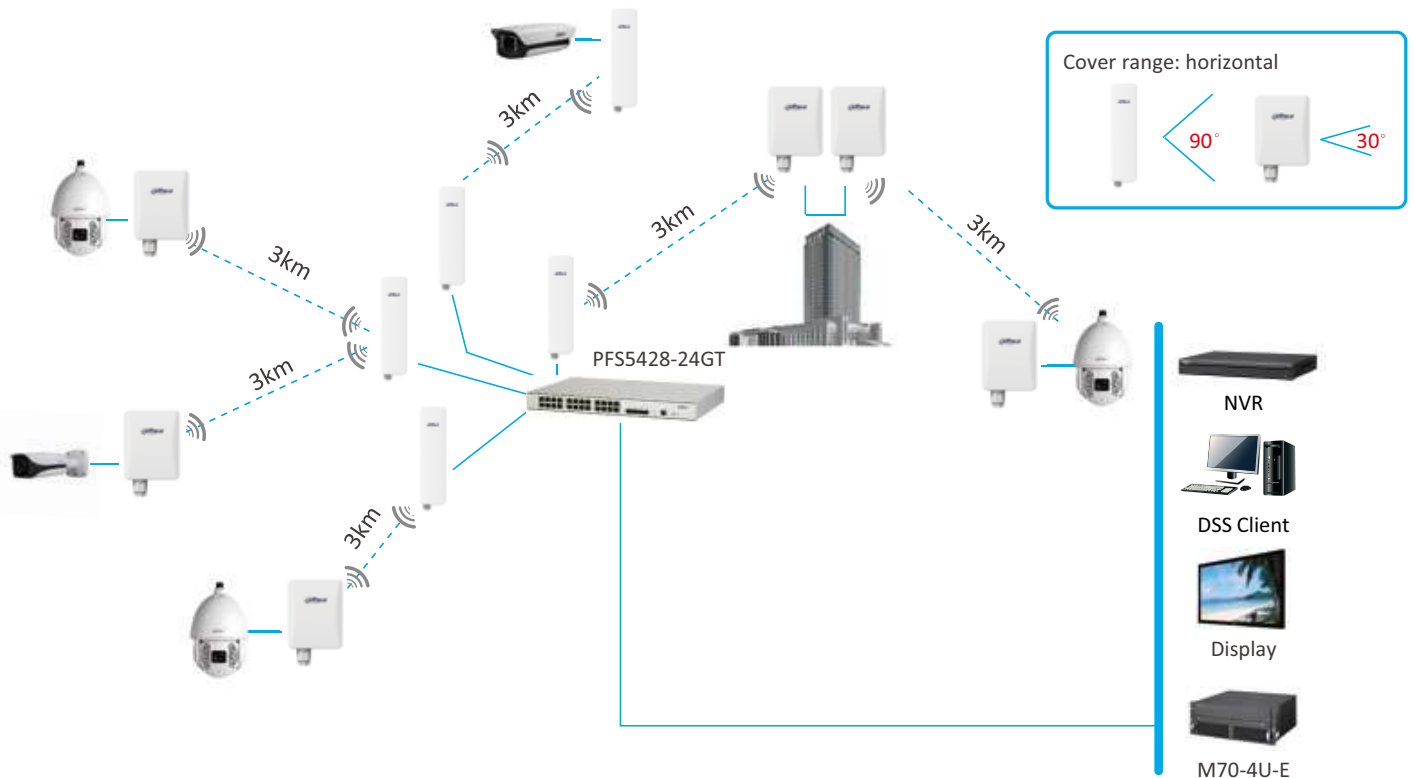
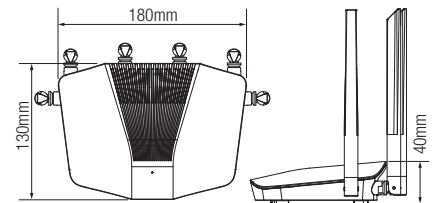

# Accessori

- Una gamma completa
- Ampio range di temperature di esercizio



## MIDSPAN PoE

<b>SWC1P25</b>	M-0003836	<b>Prezzo € 20,00</b>
----------------	-----------	-----------------------



**Caratteristiche**

Iniettore con 1 porta Gigabit PoE <25 W

<b>TAM01GT01GT-75</b>	M-0014025	<b>Prezzo € 53,00</b>
-----------------------	-----------	-----------------------



**Caratteristiche**

Iniettore con 2 porte Gigabit (1 PoE <75 W)

<b>TAM1GT1GT-30</b>	M-0011098	<b>Prezzo € 28,00</b>
---------------------	-----------	-----------------------



**Caratteristiche**

Iniettore 2 porte Gigabit (1 PoE 30 W)

## EXTENDER PoE

<b>PFT1300</b>	M-0000449	<b>Prezzo € 21,00</b>
----------------	-----------	-----------------------



**Caratteristiche**

Extender PoE 3 porte 10/100 Mbps <25 W (1 IN + 1 OUT + 1 telecamera) <3 W, Din Rail

<b>PFT1500</b>	M-0023878	<b>Prezzo € 83,00</b>
----------------	-----------	-----------------------



**Caratteristiche**

Extender PoE hardened Layer 2 unmanaged con 4 porte PoE 10/100 Mbps (1 <90 W, 2~4 <30 W) e 1 porta Gigabit uplink, capacità switching 2.8 Gbps, rate inoltra pacchetti 2.08 Mpps, installazione desktop o Din Rail

<b>IP04</b>	M-0002043	<b>Prezzo € 93,00</b>
-------------	-----------	-----------------------



**Caratteristiche**

Extender PoE 1 porta Gigabit 60 W

## EXTENDER - TRASMETTITORI OTTICI

<b>OTE103R</b>	M-0008946	<b>Prezzo € 56,00</b>
----------------	-----------	-----------------------



**Caratteristiche**

Ricevitore media converter 100 Mbps su 1 fibra SM, attacco FC, portata 20 km

<b>OTE103T</b>	M-0008947	<b>Prezzo € 56,00</b>
----------------	-----------	-----------------------



**Caratteristiche**

Trasmettitore media converter 100 Mbps su 1 fibra SM, attacco FC, portata 20 km

## ETHERNET OVER COAX

**LR1002-1ET** M-0000356 **Prezzo € 24,00**



**Caratteristiche**

Convertitore trasmettitore ePoE

**LR1002-1EC-V2** M-0030211 **Prezzo € 24,00**



**Caratteristiche**

Convertitore ricevitore ePoE

**LR1002** M-0000354 **Prezzo € 11,00**



**Caratteristiche**

Convertitore passivo ePoE

**POE-OUT** M-0009077 **Prezzo € 8,00**



**Caratteristiche**

Splitter PoE 12 Vdc/1A

## SPLITTER

## ALIMENTAZIONE - BARRA DIN

**EDP-75-48** M-0001688 **Prezzo € 36,00**



**Caratteristiche**

Alimentatore DIN 48V 1.6A 75 W

**EDP-240-48** M-0014400 **Prezzo € 92,00**



**Caratteristiche**

Alimentatore DIN 48V 5A 240 W

**RL-48V120W1AAD** M-0003357 **Prezzo € 57,00**



**Caratteristiche**

Alimentatore DIN per switch industriali PoE, 1 uscita a morsetti 48Vdc 120 W

## MODULI SFP

**GSFP-850-MMF** M-0022450 **Prezzo € 25,00**■ **Caratteristiche**

Modulo ottico Gigabit a doppia fibra, velocità 1 Gbps, portata 550 m, trasmissione a 850 nm, ricezione a 850 nm, attacco LC

**GSFP-1310-20-SMF** M-0021718 **Prezzo € 37,00**■ **Caratteristiche**

Modulo ottico Gigabit a doppia fibra, velocità 1 Gbps, portata 20 km, trasmissione e ricezione a 1310 nm, attacco LC

**GSFP-1310T-20-SMF** M-0028462 **Prezzo € 37,00**■ **Caratteristiche**

Modulo ottico Gigabit, velocità 1 Gbps, portata 20 km, trasmissione a 1310 nm, ricezione a 1550 nm, attacco LC

**GSFP-1310R-20-SMF** M-0028461 **Prezzo € 37,00**■ **Caratteristiche**

Modulo ottico Gigabit, velocità 1 Gbps, portata 20 km, trasmissione a 1550 nm, ricezione a 1310 nm, attacco LC

**SFP-850-MMF** M-0022452 **Prezzo € 21,00**■ **Caratteristiche**

Modulo ottico a doppia fibra, velocità 100 Mbps, portata 2 km, trasmissione a 850 nm, ricezione a 850 nm, attacco LC

**TSFP-850-MMF** M-0020508 **Prezzo € 81,00**■ **Caratteristiche**

Modulo ottico 10 Gigabit a doppia fibra, velocità 10 Gbps, portata 300 m, trasmissione a 850 nm, ricezione a 850 nm, attacco LC

**PFT3900** M-0000450 **Prezzo € 29,00**■ **Caratteristiche**

Modulo ottico SFP 155 Mbps su 2 fibre MM, portata 2 Km, trasmissione e ricezione a 850 nm, attacco LC

**PFT3950** M-0000451 **Prezzo € 29,00**■ **Caratteristiche**

Modulo ottico SFP 1.25 Gbps su 2 fibre MM, portata 500 m, trasmissione e ricezione 850 nm, attacco LC

**TSFP-1270T-20-SMF** M-0028466 **Prezzo € 162,00**■ **Caratteristiche**

Modulo ottico SFP 10 Gbps su 1 fibra SM, portata 20 km, trasmissione a 1270 nm, ricezione a 1330 nm, attacco LC

**TSFP-1270R-20-SMF** M-0028465 **Prezzo € 162,00**■ **Caratteristiche**

Modulo ottico SFP 10 Gbps su 1 fibra SM, portata 20 km, trasmissione a 1330 nm, ricezione a 1270 nm, attacco LC



## CABLAGGIO - CAT5E

PFM920I-5EUN M-0002622 Prezzo € 109,00



## ■ Caratteristiche

Matassa cavo UTP CAT5E lunghezza 305 m senza rip cord, conduttori in OFC/0.45 mm, guaina in PVC, certificazione CE CPR Eca ritardante di fiamma

PFM923I-5EUN-C M-0020577 Prezzo € 115,00



## ■ Caratteristiche

Matassa cavo UTP CAT5E lunghezza 305 m con rip cord, conduttori in OFC 99.97%/0.45 mm, guaina in LSZH (CPR E Class), colore bianco

## CABLAGGIO - CAT6

PFM920I-6UN-C M-0002624 Prezzo € 162,00



## ■ Caratteristiche

Matassa cavo UTP CAT6 lunghezza 305 m con rip cord, conduttori in OFC/0.53 mm, guaina in PVC, certificazione CPR Eca ritardante di fiamma

PFM923I-6UN-C M-0002630 Prezzo € 171,00



## ■ Caratteristiche

Matassa cavo UTP CAT6, lunghezza 305 m, con rip cord, conduttori in OFC 99.97%/0.53 mm, guaina in LSZH (CPR E Class), colore bianco

## CABLAGGIO - PATCH CORD

PFM972-5EU-1 M-0002642 Prezzo € 0,90



## ■ Caratteristiche

Patch cord UTP CAT5E, lunghezza 1 m

PFM972-5EU-2 M-0002643 Prezzo € 1,30



## ■ Caratteristiche

Patch cord UTP CAT5E, lunghezza 2 m

PFM972-5EU-3 M-0002644 Prezzo € 1,70



## ■ Caratteristiche

Patch cord UTP CAT5E, lunghezza 3 m

PFM972-6U-1 M-0002645 Prezzo € 1,50



## ■ Caratteristiche

Patch cord UTP CAT6, lunghezza 1 m

PFM972-6U-2 M-0002646 Prezzo € 2,00



## ■ Caratteristiche

Patch cord UTP CAT6, lunghezza 2 m

PFM972-6U-3 M-0002647 Prezzo € 2,50



## ■ Caratteristiche

Patch cord UTP CAT6, lunghezza 3 m

## CONNETTORI - PRESA JACK RJ45

PFM970-5EU

M-0002638

Prezzo € 50,00



■ **Caratteristiche**

Presca RJ45 keystone jack standard per UTP CAT5E (30 pezzi)

PFM970-6U

M-0002639

Prezzo € 51,00



■ **Caratteristiche**

Presca RJ45 keystone jack standard per UTP CAT6 (30 pezzi)

## CONNETTORI - JACK RJ45

PFM976-531

M-0014754

Prezzo € 6,00



■ **Caratteristiche**

Connettore RJ45 per cavo UTP CAT5E (100 pezzi)

PFM976-631

M-0014755

Prezzo € 9,00



■ **Caratteristiche**

Connettore RJ45 per cavo UTP CAT6 (100 pezzi)

## CONNETTORI - COVER

AP001-BPO

M-0001416

Prezzo € 0,16



■ **Caratteristiche**

Cover per connettore RJ45 arancione

AP001-BPR

M-0001417

Prezzo € 0,16



■ **Caratteristiche**

Cover per connettore RJ45 rossa

AP001-BPW

M-0001418

Prezzo € 0,16



■ **Caratteristiche**

Cover per connettore RJ45 bianca

AP001-BPY

M-0001419

Prezzo € 0,16



■ **Caratteristiche**

Cover per connettore RJ45 gialla

## PINZE

AT005

M-0001491

Prezzo € 40,00



■ **Caratteristiche**

Pinza per connettori RJ45

AT006

M-0000053

Prezzo € 14,00



■ **Caratteristiche**

Spelafili universale per cavi coassiali e UTP

## RACK - CABINET

**PFC200D-6U4D** M-0013024 **Prezzo € 136,00**■ **Caratteristiche**

Cabinet rack 19" 6U in SPCC,  
600x372x450 mm, capacità carico  
40 kg

**PFC200D-9U4D** M-0013025 **Prezzo € 159,00**■ **Caratteristiche**

Cabinet rack 19" 9U in SPCC,  
600x505x450 mm, capacità carico  
40 kg

**PFC200D-12U4D** M-0013026 **Prezzo € 184,00**■ **Caratteristiche**

Cabinet rack 19" 12U in SPCC,  
600x638x450 mm, capacità carico  
40 kg

**PFC200D-18U6D** M-0013027 **Prezzo € 409,00**■ **Caratteristiche**

Cabinet rack 19" 18U in SPCC,  
600x990x600 mm, capacità carico  
300 kg

**PFC200D-42U8D** M-0013028 **Prezzo € 798,00**■ **Caratteristiche**

Cabinet rack 19" 42U in SPCC,  
600x2055x800 mm, capacità carico  
300 kg



## RACK - RIPIANI CABINET

**PFC610-4D**

M-0002543

**Prezzo € 19,00**■ **Caratteristiche**

Ripiano per cabinet rack 19" serie PFC200D, 489x48x275 mm

**PFC610-6D**

M-0013029

**Prezzo € 23,00**■ **Caratteristiche**

Ripiano per cabinet rack 19" serie PFC200D, 472x48x350 mm

**PFC610-8D**

M-0013030

**Prezzo € 19,00**■ **Caratteristiche**

Ripiano per cabinet rack 19" serie PFC200D, 472x48x550 mm

**PFH101**

M-0002547

**Prezzo € 47,00**■ **Caratteristiche**

Ripiano per cabinet rack 1U/Mini1U/Compact1U, 483x44x281 mm

## RACK - VENTOLE

**CFT02**

M-0016763

**Prezzo € 97,00**■ **Caratteristiche**

Fan a 2 unità per cabinet 6/9/12U

**CFT02-T66**

M-0016764

**Prezzo € 70,00**■ **Caratteristiche**

Fan a 2 unità per cabinet 18U

**CFT04-T66**

M-0016765

**Prezzo € 139,00**■ **Caratteristiche**

Fan a 4 unità per cabinet 42U

**ZZM10-PDU**

M-0004274

**Prezzo € 64,00**■ **Caratteristiche**

Ciabatta 8 prese Schuko, input 250 Vac, output 4000 W

## RACK - ALIMENTAZIONE

## RACK - PATCH PANEL

**PFM973M-5EU-24**

M-0002648

**Prezzo € 57,00**■ **Caratteristiche**

Patch panel 24 porte keystone jack standard CAT5E, altezza 1U

**PFM973M-6U-24**

M-0002649

**Prezzo € 70,00**■ **Caratteristiche**

Patch panel da 24 porte keystone jack standard CAT6, altezza 1U

A series of horizontal dashed lines for writing notes.

# MEMORY

① Contributo SIAE incluso nel prezzo



**SSD INTERNI - SSD PORTABLE - HDD  
DRAM - MEMORY CARD - FLASH DRIVE USB**

## Serie SSD-C800A\*



### Caratteristiche

Unità SSD SATA 2.5", capacità da 120G a 2TB, porta SATA 6 Gb/s, velocità lettura Max. 550 MB/s, velocità scrittura Max. 500 MB/s, memoria 3D NAND, S.M.A.R.T, TRIM, TBW da 50 a 800TB

Dimensioni: 100.2 × 69.9 × 7 mm - Peso: 40 gr.

Codice	*S120G	*S128G	*S240G	*S256G	*S480G
Metel	M-0019420	M-0020572	M-0019421	M-0020573	M-0019422
Capacità	120 GB	128 GB	240 GB	256 GB	480 GB
Unità	2.5"				
Porta	SATA 6 Gb/s				
Memoria	3D NAND				
Velocità Lettura	550 MB/s	550 MB/s	550 MB/s	550 MB/s	550 MB/s
Velocità Scrittura	420 Mb/s	360 Mb/s	460 Mb/s	460 Mb/s	470 Mb/s
Temp. d'esercizio	0°C ~ +70°C				
Temp. di stoccaggio	-40°C ~ +85°C				
TBW	50 TB	50 TB	100 TB	100 TB	150 TB
Prezzo	€ 16,00	€ 17,00	€ 29,00	€ 30,00	€ 52,00

Codice	*S500G	*S512G	*S960G	*S1TB	*S2TB
Metel	M-0020574	M-0027401	M-0019423	M-0030660	M-0030659
Capacità	500 GB	512 GB	960 GB	1 TB	2 TB
Unità	2.5"				
Porta	SATA 6 Gb/s				
Memoria	3D NAND				
Velocità Lettura	530 MB/s	550 MB/s	550 MB/s	550 MB/s	540 MB/s
Velocità Scrittura	500 Mb/s	490 Mb/s	490 Mb/s	500 Mb/s	460 Mb/s
Temp. d'esercizio	0°C ~ +70°C				
Temp. di stoccaggio	-40°C ~ +85°C				
TBW	200 TB	200 TB	310 TB	400 TB	800 TB
Prezzo	€ 58,00	€ 52,00	€ 97,00	€ 98,00	€ 199,00

## Serie SSD-E800\*



## ■ Caratteristiche

Unità SSD SATA 2.5", capacità da 128 a 512 GB, velocità lettura 550 MB/s, velocità scrittura Max. 490 MB/s, memoria 3D TLC, TBW da 60 a 256 TB

Dimensioni: 100.2 × 69.9 × 7 mm - Peso: 40 gr.

Codice	*S128G	*S256G	*S512G
Metel	M-0019428	M-0019429	M-0019430
Capacità	128 GB	256 GB	512 GB
Unità	2.5"		
Porta	SATA 6 Gb/s		
Memoria	3D TLC		
Velocità Lettura	550 MB/s	550 MB/s	550 MB/s
Velocità Scrittura	410 Mb/s	470 Mb/s	490 Mb/s
Temp. d'esercizio	0°C ~ +70°C		
Temp. di stoccaggio	-40°C ~ +85°C		
TBW	60 TB	128 TB	256 TB
Prezzo	€ 17,00	€ 30,00	€ 52,00

## Serie SSD-C800N\*



## ■ Caratteristiche

SSD SATA M.2 2280, capacità da 256 a 1 TB, porta SATA 6 Gb/s, velocità lettura 530 MB/s, velocità scrittura 450/500 MB/s, memoria 3D TLC, S.M.A.R.T., TRIM, TBW da 100 a 400 TB

Dimensioni: 80 × 22 × 2.20 mm - Peso: 8 gr.

Codice	*256G	*512G	*1TB
Metel	M-0019425	M-0019426	M-0019424
Capacità	256 GB	512 GB	1 TB
Unità	M.2 2280		
Porta	SATA 6 Gb/s		
Memoria	3D NAND		
Velocità Lettura	530 MB/s	530 MB/s	530 MB/s
Velocità Scrittura	450 Mb/s	450 Mb/s	500 Mb/s
Temp. d'esercizio	0°C ~ +70°C		
Temp. di stoccaggio	-40°C ~ +85°C		
TBW	100 TB	200 TB	400 TB
Prezzo	€ 30,00	€ 53,00	€ 128,00



## Serie SSD-E900\*



## ■ Caratteristiche

SSD PCIe Gen 3.0x4 da 128 GB a 1 TB, 3D NAND, velocità lettura 1250/2000 MB/s, velocità scrittura Max. 1600 MB/s, TBW da 80 a 512 TB

Dimensioni: 80 × 23 × 4.8 mm - Peso: 8 gr.

Codice	*N128G	*SN256G	*N512G	*N1TB
Metel	M-0030240	M-0019432	M-0019433	M-0019431
Capacità	128 GB	256 GB	512 GB	1 TB
Unità	M.2 2280			
Porta	PCIe Gen 3.0 x 4			
Memoria	3D NAND			
Velocità Lettura	1250 MB/s	2000 MB/s	2000 MB/s	2000 MB/s
Velocità Scrittura	650 Mb/s	1050 Mb/s	1450 Mb/s	1600 Mb/s
Temp. d' esercizio	0°C ~ +70°C			
Temp. di stoccaggio	-40°C ~ +85°C			
TBW	80 TB	128 TB	256 TB	512 TB
Prezzo	€ 25,00	€ 38,00	€ 60,00	€ 111,00

## Serie SSD-C900A\*



## ■ Caratteristiche

SSD PCIe Gen 3.0x4 da 500 a 2000 GB, 3D TLC, velocità lettura 2500/3000 MB/s, velocità scrittura 1000/1800 MB/s, TBW da 200 a 800 TB

Dimensioni: 80 × 22 × 3.6 mm - Peso: 8 gr.

Codice	*N500G	*AN1000G	*N2000G
Metel	M-0029694	M-0029695	M-0029696
Capacità	500 GB	1000 GB	2000 GB
Unità	M.2 2280		
Porta	PCIe Gen 3.0 × 4		
Memoria	3D NAND		
Velocità Lettura	2500 MB/s	2500 MB/s	3000 MB/s
Velocità Scrittura	1000 Mb/s	1800 Mb/s	1800 Mb/s
Temp. d' esercizio	0°C ~ +70°C		
Temp. di stoccaggio	-40°C ~ +85°C		
TBW	200 TB	400 TB	800 TB
Prezzo	€ 70,00	€ 112,00	€ 211,00

## Serie SSD-C900V\*



## ■ Caratteristiche

SSD NVMe M.2 2280, capacità da 256 GB a 1 TB, Pcle Gen 3.0x4, velocità lettura Max. 3400 MB/s, velocità scrittura Ma. 3000 MB/s, memoria 3D TLC, S.M.A.R.T., TRIM, TBW da 128 a 512 TB

Dimensioni: 80 × 23 × 4.8 mm - Peso: 8 gr.

Codice	*N256G	*N512G	*N1TB
Metel	M-0019427	M-0016006	M-0015938
Capacità	256 GB	512 GB	1 TB
Unità	M.2 2280		
Porta	PCIe Gen 3.0 x 4		
Memoria	3D TLC		
Velocità Lettura	3000 MB/s	3200 MB/s	3400 MB/s
Velocità Scrittura	1450 Mb/s	2500 Mb/s	3000 Mb/s
Temp. d'esercizio	0°C ~ +70°C		
Temp. di stoccaggio	-40°C ~ +85°C		
TBW	128 TB	256 TB	512 TB
<b>Prezzo</b>	<b>€ 42,00</b>	<b>€ 70,00</b>	<b>€ 119,00</b>

## Serie SSD-C970\*



## ■ Caratteristiche

SSD PCIe Gen 4.0x4 da 256 GB a 1 TB, 3D NAND velocità lettura Max. 5000 MB/s, velocità scrittura Max. 4700 MB/s, TBW da 500 a 2000 TB

Dimensioni: 80 × 22 × 2.25 mm - Peso: 8 gr.

Codice	*N256G	*N512G	*N1TB
Metel	M-0021423	M-0021424	M-0021420
Capacità	256 GB	512 GB	1 TB
Unità	M.2 2280		
Porta	PCIe Gen 4.0 × 4		
Memoria	3D NAND		
Velocità Lettura	4600 MB/s	5000 MB/s	5000 MB/s
Velocità Scrittura	1400 Mb/s	2800 Mb/s	4700 Mb/s
Temp. d'esercizio	0°C ~ +70°C		
Temp. di stoccaggio	-40°C ~ +85°C		
TBW	500 TB	1000 TB	2000 TB
<b>Prezzo</b>	<b>€ 52,00</b>	<b>€ 84,00</b>	<b>€ 135,00</b>

## SSD-C970 Pro



### Caratteristiche

SSD PCIe Gen 4.0x4 da 1 TB, 3D NAND, velocità lettura 7400 MB/s, velocità scrittura 5200 MB/s, TBW 500 TB

Dimensioni: 80 × 22 × 3.6 mm - Peso: 8 gr.

Codice	SSD-C970PN1TB
Metel	M-0029697
Capacità	1 TB
Unità	M.2 2280
Porta	PCIe Gen 4.0 x 4
Memoria	3D TLC
Velocità Lettura	7400 MB/s
Velocità Scrittura	5200 Mb/s
Temp. d'esercizio	0°C ~ +70°C
Temp. di stoccaggio	-40°C ~ +85°C
TBW	500 TB
<b>Prezzo</b>	<b>€ 229,00</b>

## Serie SSD-S810G\*



### Caratteristiche

Unità SSD SATA 2.5" specifico per videosorveglianza, capacità da 240 a 960 GB, velocità lettura Max. 550 MB/s, velocità scrittura Max. 500 MB/s, TBW da 639 a 2557 TB

Dimensioni: 100.2 × 69.9 × 7 mm - Peso: 80 gr.

Codice	*S240G	*S480G	*S960G
Metel	M-0015939	M-0015940	M-0015941
Capacità	240 GB	480 GB	1 TB
Unità	2.5"		
Porta	6 Gb/s SATA		
Memoria	3D TLC		
Velocità Lettura	550 MB/s	520 MB/s	510 MB/s
Velocità Scrittura	470 Mb/s	480 Mb/s	500 Mb/s
Temp. d'esercizio	0°C ~ +70°C		
Temp. di stoccaggio	-40°C ~ +85°C		
TBW	620 TB	1250 TB	2500 TB
<b>Prezzo</b>	<b>€ 88,00</b>	<b>€ 140,00</b>	<b>€ 298,00</b>

## Serie SSD-S820G\*



### Caratteristiche

Unità SSD SATA 2.5" specifico per videosorveglianza, capacità da 512 GB a 2 TB, velocità lettura Max. 530 MB/s, velocità scrittura Max. 460 MB/s, TBW da 1000 a 4000 TB

Dimensioni: 100.2 × 69.9 × 7 mm - Peso: 40 gr.

Codice	*S512G	*S1TB	*S2TB
Metel	M-0027532	M-0027531	M-0027534
Capacità	512 GB	1 TB	2 TB
Unità	2.5"		
Porta	6 Gb/s SATA		
Memoria	3D NAND		
Velocità Lettura	530 MB/s	480 MB/s	480 MB/s
Velocità Scrittura	460 Mb/s	460 Mb/s	440 Mb/s
Temp. d'esercizio	0°C ~ +70°C		
Temp. di stoccaggio	-40°C ~ +85°C		
TBW	1000 TB	2000 TB	4000 TB
<b>Prezzo</b>	<b>€ 113,00</b>	<b>€ 218,00</b>	<b>€ 404,00</b>

## Serie SSD-S820N\*



### Caratteristiche

SSD SATA M.2 specifico per videosorveglianza, capacità 512 GB 7 1 TB, velocità lettura Max. 550 MB/s, velocità scrittura 460 MB/s, TBW 1000/2000 TB

Dimensioni: 80 × 22 × 2.20 mm - Peso: 8 gr.

Codice	*512G-G1YTTANN8	*1TB-G1YTTANN8
Metel	M-0030776	M-0030361
Capacità	512 GB	1 TB
Unità	M.2 2280	
Porta	6Gb/s	
Memoria	3D NAND	
Velocità Lettura	550 MB/s	490 MB/s
Velocità Scrittura	460 Mb/s	460 Mb/s
Temp. d'esercizio	0°C ~ +70°C	
Temp. di stoccaggio	-40°C ~ +85°C	
TBW	1000 TB	2000 TB
<b>Prezzo</b>	<b>€ 109,00</b>	<b>€ 213,00</b>

## Serie PSSD-T70-\*



## ■ Caratteristiche

Unità SSD portable, capacità da 500 GB a 2 TB, velocità lettura 510 MB/s, velocità scrittura 490 MB/s, USB 3.2 Gen2, Type-C, TBW da 310 a 1240 TB

Dimensioni: 89 × 51 × 9 mm - Peso: 48.5 gr.

Codice	*500G	*1TB	*2TB
Metel	M-0029733	M-0029734	M-0030777
Capacità	500 GB	1 TB	2 TB
Protocollo di interfaccia	USB3.2 Gen2 Type-C		
Velocità Lettura	510 MB/s		
Velocità Scrittura	490 Mb/s		
Temp. d' esercizio	0°C ~ +50°C		
Temp. di stoccaggio	-20°C ~ +70°C		
TBW	310 TB	620 TB	1240 TB
<b>Prezzo</b>	<b>€ 89,00</b>	<b>€ 150,00</b>	<b>€ 271,00</b>

## Serie eHDD-E10



## ■ Caratteristiche

Hard Disk esterno allo stato solido E10, capacità 1/2 TB, velocità lettura/scrittura 140 MB/s, colore grigio/blu

Dimensioni: 123.5 × 78 × 19 mm - Peso: 225 gr.

Codice	eHDD-E10-1T	eHDD-E10-2T
Metel	M-0017234	M-0017235
Capacità	1 TB	2 TB
File System	NTFS	
Compatibilità	Windows XP/7/8/8.1/10, Linux 2.6, or MAC OS 10.6 e successivi	
Velocità Lettura	140 MB/s	
Velocità Scrittura	140 Mb/s	
Temp. d' esercizio	0°C ~ +60°C	
Temp. di stoccaggio	-40°C ~ +85°C	
<b>Prezzo</b>	<b>€ 97,00</b>	<b>€ 140,00</b>

## Serie DDR-C160\*



## Caratteristiche

Modulo memoria DDR3 per laptop / PC desktop, frequenza 1600 MHz, 4/8 GB, SODIMM / UDIMM

Codice	*S4G16	*S8G16	*U8G16
Metel	M-0016138	M-0016139	M-0016140
Capacità	4 GB	8 GB	8 GB
Frequenza	1600 MHz		
Prezzo	€ 18,00	€ 29,00	€ 29,00

## Serie DDR-C300S\*



## Caratteristiche

Modulo memoria DDR4 per laptop, frequenza 2666/3200 MHz, 4/8 GB, SODIMM

Codice	*4G26	*8G26	*8G32
Metel	M-0030779	M-0016136	M-0027545
Capacità	4 GB	8 GB	8 GB
Frequenza	2666 MHz		3200 MHz
Prezzo	€ 24,00	€ 39,00	€ 32,00

## Serie DDR-C300U\*



## Caratteristiche

Modulo memoria DDR4 per PC desktop, frequenza 2666/3200 MHz, 8/16/32 GB, UDIMM

Codice	*4G26	*8G26	*16G26	*8G32	*16G32	*32G32
Metel	M-0030449	M-0016135	M-0016137	M-0027544	M-0027511	M-0029840
Capacità	4 GB	8 GB	16 GB	8 GB	16 GB	32 GB
Frequenza	2666 MHz			3200 MHz		
Prezzo	€ 19,00	€ 36,00	€ 100,00	€ 32,00	€ 64,00	€ 297,00

## Serie TF-C100/\*



### Caratteristiche

Micro SD Card da 32 a 512 GB, velocità lettura 100 MB/s, velocità scrittura Max. 80 MB/s, Speed Class C10, U1/ C10/U3/V30 V10, TBW da 16 a 100 TB

Dimensioni: 15 × 11 × 1 mm - Peso: 0.33 gr.

Codice	*32GB	*64GB	*128GB	*256GB	*512GB
Metel	M-0029727	M-0029728	M-0029729	M-0029730	M-0029731
Capacità	32 GB	64 GB	128 GB	256 GB	512 GB
Velocità Lettura	100 MB/s				
Velocità Scrittura	28 MB/s	38 MB/s	48 MB/s	40 MB/s	80 MB/s
Valutazione Velocità	C10/U1/V10	C10/U3/V30			
File System	FAT32	exFAT			
Temp. d' esercizio	0°C ~ +70°C				
Temp. di stoccaggio	-25°C ~ +85°C				
TBW	16 TB	33 TB	66 TB	50 TB	100 TB
Prezzo	€ 9,00	€ 12,00	€ 20,00	€ 36,00	€ 90,00

## Serie TF-L100-\*



### Caratteristiche

Micro SD Card da 32 a 256 GB specifica per videosorveglianza, velocità lettura 100 MB/s, velocità scrittura Max. 80 MB/s, Speed Class C10, U1/3, V10/30, A1, P/E cycle 500

Dimensioni: 15 × 11 × 1 mm - Peso: 0.33 gr.

Codice	*32GB	*64GB	*128GB	*256GB
Metel	M-0030773	M-0030774	M-0030775	M-0027547
Capacità	32 GB	64 GB	128 GB	256 GB
Velocità Lettura	100 MB/s			
Velocità Scrittura	30 MB/s	40 MB/s	50 MB/s	80 MB/s
Valutazione Velocità	C10/U1/V10/A1	C10/U3/V30/A1		
File System	FAT32	exFAT		
Temp. d' esercizio	0°C ~ +70°C			
Temp. di stoccaggio	-25°C ~ +85°C			
TBW	10 TB	32 TB	64 TB	128 TB
Prezzo	€ 10,00	€ 16,00	€ 21,00	€ 37,00

## Serie TF-P100/\*



## ■ Caratteristiche

Micro SD Card da 32 a 512 GB specifica per videosorveglianza, velocità lettura 100 MB/s, velocità scrittura Max. 80 MB/s, Speed Class C10, U3, V30, A2, P/E cycle 1000

Dimensioni: 15 × 11 × 1 mm - Peso: 0.33 gr.

Codice	*32GB	*64GB	*128GB	*256GB	*512GB
Metel	M-0029732	M-0015328	M-0015329	M-0015841	M-0029735
Capacità	32 GB	64 GB	128 GB	256 GB	512 GB
Velocità Lettura	100 MB/s				
Velocità Scrittura	40 MB/s	60 MB/s	90 MB/s	90 MB/s	60 MB/s
Valutazione Velocità	C10/U3/V30/A2				
File System	FAT32	exFAT			
Temp. d' esercizio	0°C ~ +70°C				
Temp. di stoccaggio	-25°C ~ +85°C				
TBW	20 TB	33 TB	66 TB	132 TB	264 TB
Prezzo	€ 13,00	€ 17,00	€ 24,00	€ 39,00	€ 95,00

## Serie TF-W100-\*



## ■ Caratteristiche

Micro SD Card da 32 a 256 GB specifica per videosorveglianza, velocità lettura 100 MB/s, velocità scrittura Max. 85 MB/s, Speed Class C10, U1/3, V10/30, A2, P/E cycle 1000

Dimensioni: 15 × 11 × 1 mm - Peso: 0.33 gr.

Codice	*32GB	*64GB	*128GB	*256GB
Metel	M-0027611	M-0027535	M-0027533	M-0027612
Capacità	32 GB	64 GB	128 GB	256 GB
Velocità Lettura	100 MB/s			
Velocità Scrittura	85 MB/s	45 MB/s	75 MB/s	85 MB/s
Valutazione Velocità	C10/U1/V10/A1	C10/U3/V30/A1		
File System	FAT32	exFAT		
Temp. d' esercizio	-25°C ~ +85°C			
Temp. di stoccaggio	-40°C ~ +85°C			
TBW	85 TB	170 TB	340 TB	680 TB
Prezzo	€ 14,00	€ 23,00	€ 34,00	€ 68,00



Serie SD-H100-\*



## Caratteristiche

SD Card da 32 a 256 GB specifica per videosorveglianza, velocità lettura 100 MB/s, velocità scrittura Max. 90 MB/s, TBW da 85 a 670 TB

Dimensioni: 32 × 24 × 2.1 mm - Peso: 2 gr.

Codice	*32GB	*64GB	*128GB	*256GB
Metel	M-0027610	M-0027609	M-0027608	M-0028889
Capacità	32 GB	64 GB	128 GB	256 GB
Velocità Lettura	100 MB/s			
Velocità Scrittura	25 MB/s	50 MB/s	90 MB/s	90 MB/s
Valutazione Velocità	C10/U1/V10	C10/U3/V30		
File System	FAT32	exFAT		
Temp. d'esercizio	-25°C ~ +85°C			
Temp. di stoccaggio	-40°C ~ +85°C			
TBW	85 TB	170 TB	340 TB	680 TB
Prezzo	€ 16,00	€ 28,00	€ 53,00	€ 101,00



## Serie USB-U106-20-\*



## ■ Caratteristiche

Flash drive USB 2.0 da 4 a 64 GB, Type A, velocità lettura 10-25 MB/s, velocità scrittura 3-10 MB/s, case in metallo argento

Dimensioni: 40.4 × 12.25 × 4.65 mm - Peso: 5.7 gr.

Codice	*4GB	*8GB	*16GB	*32GB	*64GB
Metel	M-0030569	M-0029698	M-0029699	M-0029700	M-0029701
Intefaccia	USB 2.0				
Capacità	4 GB	8 GB	16 GB	32 GB	64 GB
Velocità Lettura	10-25 MB/s				
Velocità Scrittura	3-10 MB/s				
Sistema Compatibile	Windows 7/8/10; macOS10.15 e successivi; Linux 2.4.x e successivi				
File System	FAT32				exFAT
Temp. d'esercizio	0°C ~ +60°C				
Temp. di stoccaggio	-20°C ~ +70°C				
Prezzo	€ 3,00	€ 4,00	€ 6,00	€ 8,00	€ 12,00

## Serie USB-U106-30-\*



## ■ Caratteristiche

Flash drive USB 3.0 da 16 a 128 GB, Type A, velocità lettura 40-70 MB/s, velocità scrittura 9-25 MB/s, case in metallo argento

Dimensioni: 40.4 × 12.25 × 4.65 mm - Peso: 5.7 gr.

Codice	*16GB	*32GB	*64GB	*128GB
Metel	M-0015242	M-0015330	M-0015331	M-0015332
Interfaccia	USB 3.0			
Capacità	16 GB	32 GB	64 GB	128 GB
Velocità Lettura	40-70 MB/s			
Velocità Scrittura	9-25 MB/s			
Sistema Compatibile	Windows 7/8/10; macOS10.15; Linux 2.4.x e successivi			
File System	FAT32		exFAT	
Temp. d'esercizio	0°C ~ +60°C			
Temp. di stoccaggio	-20°C ~ +70°C			
Prezzo	€ 7,00	€ 10,00	€ 14,00	€ 28,00

## Serie USB-U116-20-\*



■ Caratteristiche

Flash drive USB 2.0 da 8 a 64 GB, Type A, velocità lettura 10-25 MB/s, velocità scrittura 3-10 MB/s

Dimensioni: 58.3 × 19.6 × 10.8 mm - Peso: 23 gr.

Codice	*8GB	*16GB	*32GB	*64GB
Metel	M-0029702	M-0029703	M-0029704	M-0029705
Intefaccia	USB 2.0			
Capacità	8 GB	16 GB	32 GB	64 GB
Velocità Lettura	10-25 MB/s			
Velocità Scrittura	3-10 MB/s			
Sistema Compatibile	Windows 7/8/10; macOS10.15; Linux 2.4.x e successivi			
File System	FAT32			exFAT
Temp. d'esercizio	0°C ~ +60°C			
Temp. di stoccaggio	-20°C ~ +70°C			
Prezzo	€ 4,00	€ 6,00	€ 8,00	€ 12,00

## Serie USB-U126-20-\*



■ Caratteristiche

Flash drive USB 2.0 da 4 a 32 GB, Type A, velocità lettura 8-25 MB/s, velocità scrittura 4-10 MB/s

Dimensioni: 53.4 × 21 × 8.8 mm - Peso: 4.7 gr.

Codice	*4GB	*8GB	*16GB	*32GB
Metel	M-0029706	M-0029707	M-0029708	M-0029709
Intefaccia	USB 2.0			
Capacità	4 GB	8 GB	16 GB	32 GB
Velocità Lettura	8-25 MB/s			
Velocità Scrittura	4-10 MB/s			
Sistema Compatibile	Windows 7/8/10; MacOS 10.5; Linux 2.4.x; Android 7.0 o successivi			
File System	FAT32			
Temp. d'esercizio	0°C ~ +60°C			
Temp. di stoccaggio	-20°C ~ +70°C			
Prezzo	€ 3,00	€ 4,00	€ 6,00	€ 8,00

## Serie USB-U126-30-\*



## ■ Caratteristiche

Flash drive USB 3.2 Gen1 da 16 a 64 GB, Type A, velocità lettura 15-150 MB/s, velocità scrittura 6-100 MB/s

Dimensioni: 53.4 × 21 × 8.8 mm - Peso: 4.7 gr.

Codice	*16GB	*32GB	*64GB
Metel	M-0029710	M-0029711	M-0029712
Intefaccia	USB3.2 Gen1		
Capacità	16 GB	32 GB	64 GB
Velocità Lettura	15-150 MB/s		
Velocità Scrittura	6-100 MB/s		
Sistema Compatibile	Windows 7/8/10; MacOS 10.5; Linux 2.4.x; Android 7.0 o successivi		
File System	FAT32	FAT32	exFAT
Temp. d'esercizio	0°C ~ +60°C		
Temp. di stoccaggio	-20°C ~ +70°C		
Prezzo	€ 7,00	€ 10,00	€ 14,00

## Serie USB-U156-20-\*



## ■ Caratteristiche

Flash drive USB 2.0 da 8 a 32 GB, Type A, velocità lettura 10-25 MB/s, velocità scrittura 3-10 MB/s, case in metallo grigio

Dimensioni: 41.1 × 14.8 × 6.7 mm - Peso: 8 gr.

Codice	*8GB	*16GB	*32GB
Metel	M-0022615	M-0023714	M-0026904
Intefaccia	USB2.0		
Capacità	8 GB	16 GB	32 GB
Velocità Lettura	10-25 MB/s		
Velocità Scrittura	3-10 MB/s		
Sistema Compatibile	Windows 7/8/10; MacOS 10.5; Linux 2.4.x o successivi		
File System	FAT32		
Temp. d'esercizio	0°C ~ +60°C		
Temp. di stoccaggio	-20°C ~ +70°C		
Prezzo	€ 5,00	€ 6,00	€ 8,00

## Serie USB-U156-32-\*



## ■ Caratteristiche

Flash drive USB 3.2 Gen1 da 32 a 128 GB, Type A, velocità lettura 30-110 MB/s, velocità scrittura 8-45 MB/s, case in metallo grigio

Dimensioni: 41.1 × 14.8 × 6.7 mm - Peso: 8 gr.

Codice	*32GB	*64GB	*128GB
Metel	M-0019684	M-0019685	M-0019683
Intefaccia	USB3.2 Gen1		
Capacità	32 GB	64 GB	128 GB
Velocità Lettura	3-110 MB/s		
Velocità Scrittura	8-45 MB/s		
Sistema Compatibile	Windows 7/8/10; MacOS 10.5; Linux 2.4.x o successivi		
File System	FAT32	exFAT	
Temp. d'esercizio	0°C ~ +60°C		
Temp. di stoccaggio	-20°C ~ +70°C		
Prezzo	€ 10,00	€ 14,00	€ 26,00

## Serie USB-U166-31-\*



## ■ Caratteristiche

Flash drive USB 3.2 Gen1 da 32/64 GB, Type A, velocità lettura 15-150 MB/s, velocità scrittura 6-100 MB/s

Dimensioni: 19.6 × 15.2 × 7.2 mm - Peso: 2.2 gr.

Codice	*32GB	*64GB
Metel	M-0029713	M-0029714
Intefaccia	USB3.2 Gen1	
Capacità	32 GB	64 GB
Velocità Lettura	15-150 MB/s	
Velocità Scrittura	6-100 MB/s	
Sistema Compatibile	Windows 7/8/10; MacOS 10.5; Linux 2.4.x; Android 7.0 o successivi	
File System	FAT32	exFAT
Temp. d'esercizio	0°C ~ +60°C	
Temp. di stoccaggio	-20°C ~ +70°C	
Prezzo	€ 12,00	€ 17,00

## Serie USB-U176-20-\*



## ■ Caratteristiche

Flash drive USB 2.0 da 8 a 32 GB, Type A, velocità lettura 8-25 MB/s, velocità scrittura 4-10 MB/s

Dimensioni: 54 × 18.7 × 7.3 mm - Peso: 4.5 gr.

Codice	*8GB	*16GB	*32GB	*64GB
Metel	M-0029715	M-0029716	M-0029717	M-0028182
Intefaccia	USB 2.0			
Capacità	8 GB	16 GB	32 GB	64 GB
Velocità Lettura	8-25 MB/s			
Velocità Scrittura	4-10 MB/s			
Sistema Compatibile	Windows 7/8/10; MacOS 10.5; Linux 2.4.x; Android 7.0 o successivi			
File System	FAT32			exFAT
Temp. d'esercizio	0°C ~ +60°C			
Temp. di stoccaggio	-20°C ~ +70°C			
Prezzo	€ 5,00	€ 6,00	€ 9,00	€ 12,00

## Serie USB-U176-31-\*



## ■ Caratteristiche

Flash drive USB 3.2 Gen1 da 32 a 256 GB, Type A, velocità lettura 15-150 MB/s, velocità scrittura 6-100 MB/s

Dimensioni: 54 × 18.7 × 7.3 mm - Peso: 4.5 gr.

Codice	*32GB	*64GB	*128GB	*256GB
Metel	M-0029718	M-0029719	M-0029720	M-0028183
Intefaccia	USB3.2 Gen1			
Capacità	32 GB	64 GB	128 GB	256 GB
Velocità Lettura	15-150 MB/s			
Velocità Scrittura	6-100 MB/s			
Sistema Compatibile	Windows 7/8/10; MacOS 10.5; Linux 2.4.x; Android 7.0 o successivi			
File System	FAT32	exFAT		
Temp. d'esercizio	0°C ~ +60°C			
Temp. di stoccaggio	-20°C ~ +70°C			
Prezzo	€ 10,00	€ 14,00	€ 24,00	€ 34,00

## Serie USB-P629-32-\*



## ■ Caratteristiche

Flash drive USB 3.2 Gen1 da 32 a 256 GB, Type A e Type C, velocità lettura 20-150 MB/s, velocità scrittura 6-100 MB/s, case in metallo grigio

Dimensioni: 67.3 × 18.2 × 12.8 mm - Peso: 28 gr.

Codice	*32GB	*64GB	*128GB	*256GB
Metel	M-0028757	M-0026905	M-0026906	M-0029721
Intefaccia	USB3.2 Gen1			
Capacità	32 GB	64 GB	128 GB	256 GB
Velocità Lettura	20-150 MB/s			
Velocità Scrittura	6-100 MB/s			
Sistema Compatibile	Windows 7/8/10; MacOS 10.5; Linux 2.4.x o successivi			
File System	FAT32	exFAT		
Temp. d'esercizio	0°C ~ +60°C			
Temp. di stoccaggio	-20°C ~ +70°C			
Prezzo	€ 12,00	€ 16,00	€ 25,00	€ 37,00

## Serie USB-P639-32-\*



## ■ Caratteristiche

Flash drive USB 3.2 Gen1 da 32 a 128 GB, Type A e Type C, velocità lettura 20-150 MB/s, velocità scrittura 6-100 MB/s, case in metallo grigio

Dimensioni: 38.2 × 14.4 × 9.2 mm - Peso: 11 gr.

Codice	*32GB	*64GB	*128GB
Metel	M-0024483	M-0025161	M-0023149
Intefaccia	USB3.2 Gen1		
Capacità	32 GB	64 GB	128 GB
Velocità Lettura	20-150 MB/s		
Velocità Scrittura	6-100 MB/s		
Sistema Compatibile	Windows 7/8/10; MacOS 10.5; Linux 2.4.x o successivi		
File System	FAT32	exFAT	
Temp. d'esercizio	0°C ~ +60°C		
Temp. di stoccaggio	-20°C ~ +70°C		
Prezzo	€ 13,00	€ 19,00	€ 34,00

## Serie USB-S806-32-\*



## ■ Caratteristiche

Flash drive USB 3.2 Gen2 da 128 a 512 GB, Type A, velocità lettura 520/540 MB/s, velocità scrittura 460/520 MB/s, case in metallo grigio

Dimensioni: 69 × 20 × 7.5 mm - Peso: 33 gr.

Codice	*128GB	*256GB	*512GB
Metel	M-0029722	M-0029723	M-0029724
Intefaccia	USB3.2 Gen2		
Capacità	128 GB	256 GB	512 GB
Velocità Lettura	520 GB		540 GB
Velocità Scrittura	460 GB		520 GB
Sistema Compatibile	Windows 7/8/10; MacOS 10.5; Linux 2.4.x o successivi		
File System	exFAT		
Temp. d'esercizio	0°C ~ +50°C		
Temp. di stoccaggio	-20°C ~ +70°C		
Prezzo	€ 43,00	€ 63,00	€ 91,00

## Serie USB-S809-32-\*



## ■ Caratteristiche

Flash drive USB 3.2 Gen2 da 128/256 GB, Type A e Type C, velocità lettura 520 MB/s, velocità scrittura 460 MB/s, case in metallo grigio

Dimensioni: 69 × 20 × 7.5 mm - Peso: 33 gr.

Codice	*128GB	*256GB
Metel	M-0029725	M-0029726
Intefaccia	USB3.2 Gen2	
Capacità	128 GB	256 GB
Velocità Lettura	520 GB	
Velocità Scrittura	460 GB	
Sistema Compatibile	Windows 7/8/10; MacOS 10.5; Linux 2.4.x; Android o successivi	
File System	exFAT	
Temp. d'esercizio	0°C ~ +50°C	
Temp. di stoccaggio	-20°C ~ +70°C	
Prezzo	€ 48,00	€ 63,00



A series of horizontal dashed lines for writing notes.

# VIDEOCONFERENCE



TELECAMERE WEBCAM - TELECAMERE ALL-IN-ONE  
TELECAMERE PTZ - SPEAKERPHONE MICROFONO  
CABLATO - SPEAKERPHONE BLUETOOTH - CUFFIE CON  
MICROFONO - ENDPOINT PTZ - ENDPOINT FULL HD  
UNITA' MULTICONTROLLO - PIATTAFORMA MULTIPOINT

## TELECAMERE - WEBCAM

Modello	<b>HTI-UC390</b>
Metel	M-0020584
Prezzo	€ 264,00

Webcam 8 MP, sensore CMOS 1/2.8", ottica M12 2.2 mm, campo visivo 110°, 2/3DNR, microfono (4 m) integrato, 1 porta USB 2.0 alimentazione tramite USB 5 Vdc <5 W



**4K UHD**

### Dimensioni

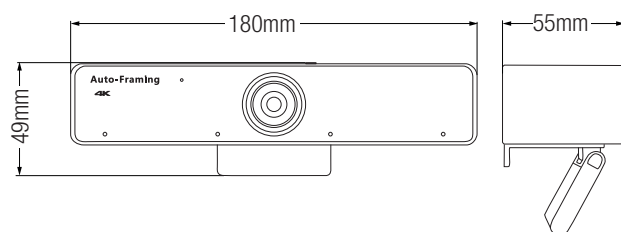

Modello	<b>HTI-UC325</b>
Metel	M-0016195
Prezzo	€ 47,00

Webcam 2 MP, sensore CMOS 1/2.8", ottica M8 3 mm, campo visivo 86°, 2/3DNR, microfono (3 m) integrato, 1 porta USB 2.0 alimentazione tramite USB 5 Vdc <1 W



### Dimensioni

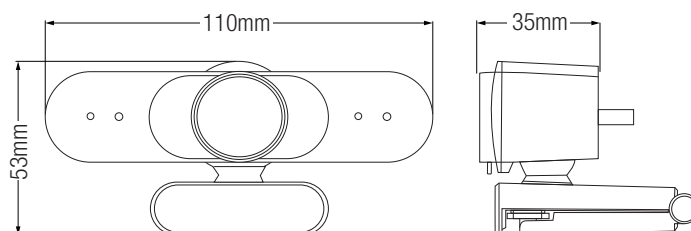

Modello	<b>HTI-UC320</b>
Metel	M-0016194
Prezzo	€ 33,00

Webcam 2 MP, sensore CMOS 1/2.8", ottica M8 3 mm, campo visivo 86°, 2/3DNR, microfono (3 m) integrato, 1 porta USB 2.0 alimentazione tramite USB 5 Vdc <1 W

Modello	<b>HTI-UC300</b>
Metel	M-0020583
Prezzo	€ 22,00

Webcam 2 MP, sensore CMOS 1/2.9", ottica M8 3 mm, campo visivo 85°, 2/3DNR, microfono (3 m) integrato, 1 porta USB 2.0 alimentazione tramite USB 5 Vdc <2 W



### Dimensioni

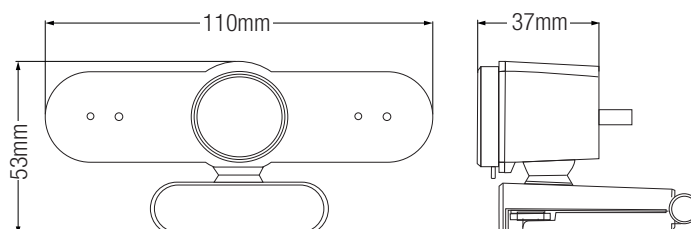

## TELECAMERE - ALL-IN-ONE

Modello	<b>VCS-C5A0</b>
Metel	M-0020585
Prezzo	€ 752,00

Telecamera USB 4K per videoconferenze, sensore CMOS 1/2.5", zoom 5x, campo visivo 121° (DFOV)/110° (HFOV)/75° (VFOV), tripode inclinabile integrato ( $\pm 15^\circ$ ), H.264, 2/3DNR, microfono (6 m) e speaker 96 dB integrati, 1 uscita HDMI 1.4b, 1 porta USB 3.0 type C, 1 porta USB 2.0 type A, Bluetooth 5.0, blocco Kensington, alimentazione 12 Vdc



**4K UHD**

### Dimensioni

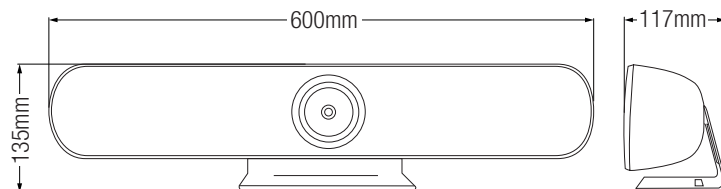

Modello	<b>VCS-C4B0</b>
Metel	M-0028835
Prezzo	€ 288,00

Torretta USB con telecamera 2 MP e speaker integrati, sensore CMOS 1/2.9", ottica M12-P0.5 2.9 mm, campo visivo 110°, 2/3DNR, microfono 4 unità MEMS (4 m) integrato, 1 porta USB 2.0 Type-C, alimentazione tramite USB 5 Vdc <2.5 W



### Dimensioni

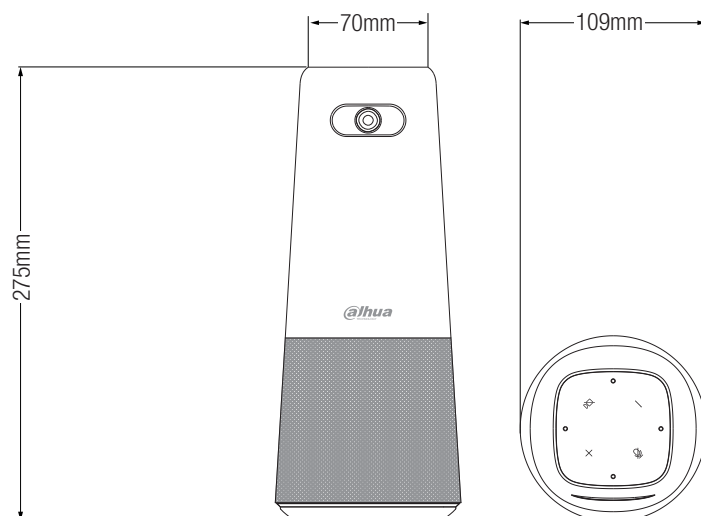

## TELECAMERE - PTZ

Modello	<b>VCS-C7A0</b>
Metel	M-0030319
Prezzo	€ 965,00

Telecamera PTZ 2.1 MP per videoconferenze, sensore CMOS 1/2.8", ottica 3.9~46.8 mm, zoom 12x, campo visivo 6.55°~73°, PAN -120°~+120°/TILT -30°~+30°, 1 HDMI, 1 3G SDI, 1 CVBS/HDCVI, 2 RS232/RS485, 1 porta LAN, protocollo VISCA, alimentazione 12 Vdc <32 W



### Dimensioni

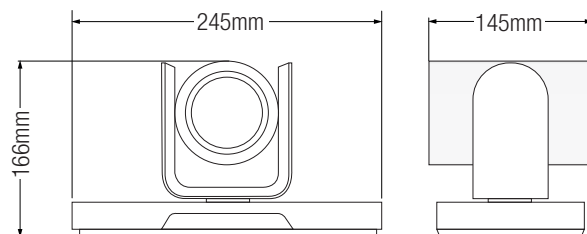

Modello	<b>VCS-C5B0</b>
Metel	M-0016193
Prezzo	€ 613,00

Telecamera PTZ USB 2.13 MP per videoconferenze, sensore CMOS 1/2.8", ottica 4.7~47 mm, zoom 10x, campo visivo 6.43°~60.9°, PAN -90°~+90°/TILT -20°~+20°, H.264, 2/3DNR, microfono (6 m) e speaker integrati, 1 porta USB 3.0/2.0, 1 porta RS232, alimentazione 12 Vdc



### Dimensioni

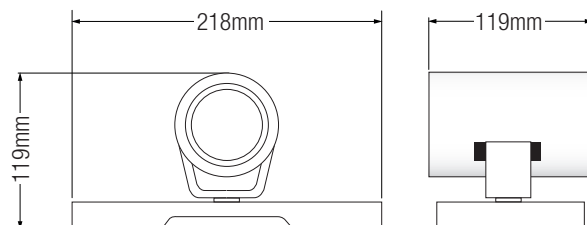

## SPEAKERPHONE - MICROFONO CABLATO

Modello	<b>VCS-MCA300</b>
Metel	M-0020586
Prezzo	€ 362,00

Microfono digitale omnidirezionale cablato per videoconferenze, raggio di raccolta 6 metri, frequenza campionamento 48 KHz, sensibilità -36 dB, 3 livelli in cascata, USB 2.0, alimentazione tramite USB



### Dimensioni

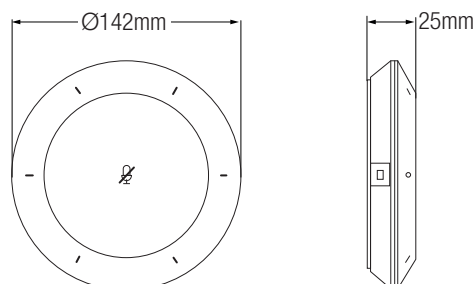

## SPEAKERPHONE - BLUETOOTH

Modello	<b>VCS-MCA400</b>
Metel	M-0020588
Prezzo	€ 226,00

Speakerphone omnidirezionale per videoconferenze, raggio di raccolta 4 metri, USB Type-C, Bluetooth, 1 livello in cascata, alimentazione tramite USB, batteria al litio integrata



### Dimensioni

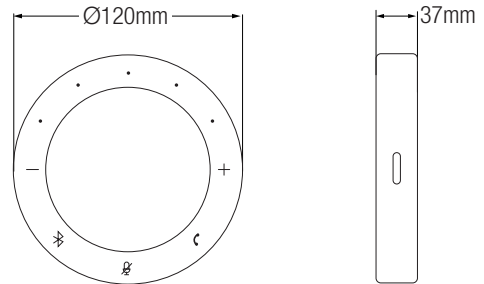

Modello	<b>VCS-MCA450</b>
Metel	M-0030284
Prezzo	€ 105,00

Speakerphone omnidirezionale per videoconferenze, raggio di raccolta 5 metri, USB Type-C, Bluetooth, alimentazione tramite USB, batteria al litio integrata



### Dimensioni

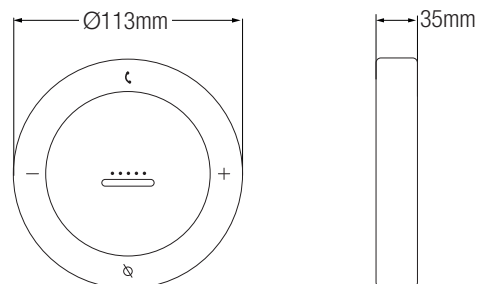

## CUFFIE CON MICROFONO

Modello	<b>VCS-ER200</b>
Metel	M-0027510
Prezzo	€ 103,00

Cuffie con microfono cablate plug & play, doppio microfono direzionale e omnidirezionale, eliminazione rumore AI, frequenza 100 Hz~10 kHz + 20 Hz ~ 20 kHz, volume speaker 118 ±2 dB a 1 mW, pulsantiera su cavo (tasto pausa, chiamata, muto, volume up/down), indicatore di stato, lunghezza cavo USB 4 m, alimentazione tramite USB 5V <5 W



### Dimensioni



## ENDPOINT CON PTZ

Modello	<b>VCS-TS51A0</b>
Metel	M-0025918
Prezzo	€ 3.792,00

Endpoint con PTZ per videoconferenze, 2 MP, risoluzione 1080p @60fps, zoom ottico 12x, campo visivo 73°, H.265, codifica audio OPUS, frequenza campionamento 48 KHz



### Dimensioni

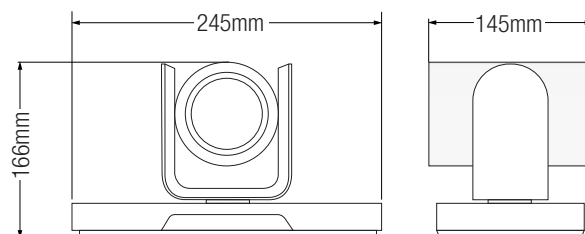

## ENDPOINT FULL-HD

Modello	<b>VCS-TS52A0</b>
Metel	M-0029852
Prezzo	€ 6.542,00

Endpoint per videoconferenze Full-HD, H.265, codec audio OPUS, video: 2 HDMI, 1 3G-SDI, 1 CVBS, 1 HDCVI, 1 HDMI/DVI/VGA/YPbPr, audio: 2 XLR, 2 RCA, 1 6.35 mm, 1 DH-AI, 1 HDMI, 2 porte Gigabit LAN, 1 porta USB, 2 porte RS232/RS485, alimentazione 12 Vdc <60 W



### Dimensioni

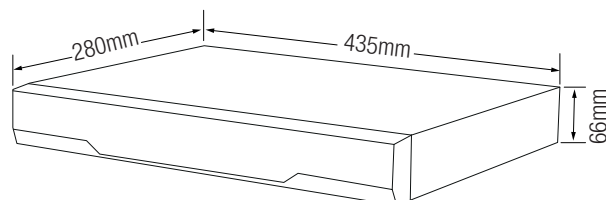

## UNITÀ MULTI-CONTROLLO

Modello	<b>VCS-MPC95F-4K</b>
Metel	M-0030286
Prezzo	€ 30.306,00

Unità multi-controllo per videoconferenze, supporto fino a 2 business board e 80 siti, 1080 @30fps, hot swap, espandibile in cascata



### Dimensioni

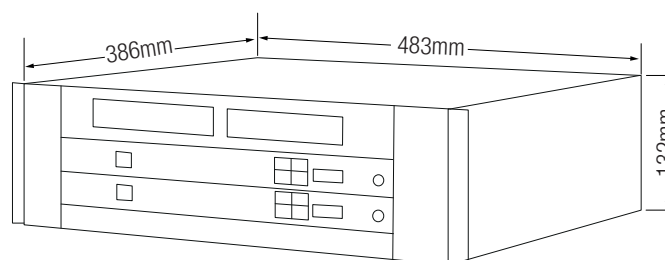

## PIATTAFORMA MULTI-POINT

Modello	<b>VCS-MCU95F0-4K</b>
Metel	M-0029851
Prezzo	€ 22.081,00

Piattaforma di gestione per videoconferenze Full-HD, H.265, codec audio OPUS, interfacce: 4 HDMI, 2 USB 3.0, 1 porta USB seriale, 1 porta Gigabit LAN di gestione, 4 porte Giabit LAN, 2 SSD 256 GB, 3U, alimentazione ridondante 1+1 800 W Hot-swap



### Dimensioni

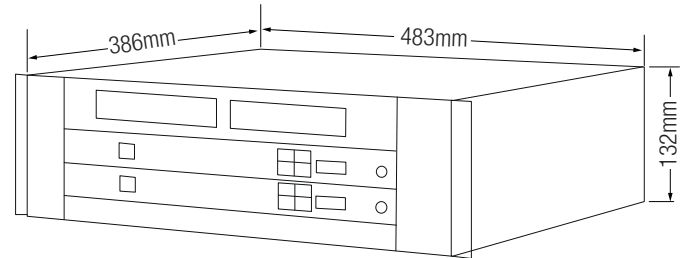



## CARATTERISTICHE

### DIMENSIONI COMPATTE

Le webcam Dahua sono progettate per ridurre al minimo l'ingombro. Dimensioni compatte, campo visivo molto ampio e altissima risoluzione regalano agli utenti un'esperienza di videoconferenza eccezionale anche negli spazi più angusti.



### DESIGN TUTTO-IN-UNO

L'integrazione di telecamera, microfono e speaker in un unico dispositivo rende le telecamere USB All-in-one Dahua l'ideale per sale meeting di medie dimensioni grazie anche a facilità di utilizzo, risoluzione UHD, ampio campo visivo ed elevata qualità audio/video.

### MASSIMA FLESSIBILITÀ

Per soddisfare i requisiti delle sale conferenze più estese ci sono i modelli della serie Conference. La telecamera PTZ può essere controllata da remoto regolando angolazione e ampiezza del campo visivo. Grazie alla tecnologia anti-vibrazione elettronica l'immagine è sempre stabile.

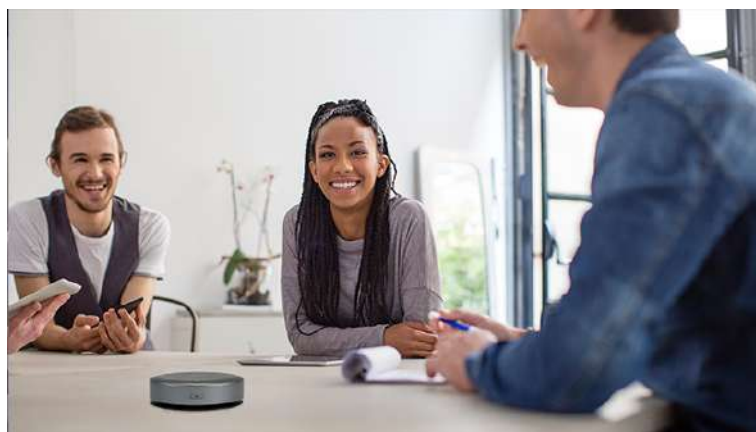

### SUONO CRISTALLINO

I prodotti Mic & Speaker offrono la massima versatilità in termini di design ed effetti sonori per adattarsi al meglio in ogni ambiente, dalla cameretta più piccola alle meeting room più affollate, garantendo sempre conversazioni chiare.

Dotted lines for writing a note.





...QUALITY BY DESIGN

Distribuito da

\* Design e specifiche sono soggette a modifiche senza preavviso.

Listino IT 03-2023\_V.1.0



**DAHUA TECHNOLOGY ITALY**

Via Cesare Cantù, 8/10 - 20092 Cinisello Balsamo (MI)

Tel: +39 02 99912900

Email: [info.italy@dahuatech.com](mailto:info.italy@dahuatech.com)

[www.dahuasecurity.com/it](http://www.dahuasecurity.com/it)



© Dahua Technology, All rights reserved