

DH-IPC-HFW7442H-Z4-S2

4MP IR Bullet WizMind Network Camera



WizMind

Launched by Dahua Technology, Dahua WizMind is a full portfolio of solutions composed of project-oriented products including IPC, NVR, PTZ, XVR, Thermal and software platform which adopts industry-leading deep learning algorithms. Focusing on customer's requirements, WizMind provides precise, reliable and comprehensive AI solutions for verticals.

Series Overview

With advanced deep learning algorithm, Dahua WizMind 7 Series network camera supports various intelligent functions and satisfies the requirements in different scenes. The camera can accurately recognize person, vehicle, and non-motor vehicle, face, and liveness. This series camera has ultra starlight night version effect, and works with ultra-low stream. It supports dust-proof function, waterproof function and vandal-proof function, complying with the standards of IP67 and IK10 (Supported by some select models).

Functions

Smart H.265+ & Smart H.264+

With advanced scene-adaptive rate control algorithm, Dahua smart encoding technology realizes the higher encoding efficiency than H.265 and H.264, provides high-quality video, and reduces the cost of storage and transmission.

Starlight+

With advanced image processing technology, optical technology, and image sensor of large target surface, Dahua Starlight+ technology can provide clear colorful video in the environment of ultra-low illuminance. It applies to various environments of low illuminance.

Video Metadata

With deep learning algorithm, Dahua Video Metadata technology can detect, track, capture vehicle, non-motor vehicle and people, and select the best images, and extract attributes.

- 4-MP 1/1.8" CMOS image sensor, low luminance, and high definition image.
- Outputs max. 4 MP (2688 × 1520)@50/60 fps.
- H.265 codec, high compression rate, ultra-low bit rate.
- ROI, SMART H.264 +/H.265+, flexible coding, applicable to various bandwidth and storage environments.
- Built-in IR LED, and the max. illumination distance is 120 m.
- Rotation mode, WDR, 3D NR, HLC, BLC, digital watermarking, applicable to various monitoring scenes.
- With deep learning algorithm, it supports video metadata, face detection, face recognition, people counting, perimeter protection, etc.
- Supports P-Iris, the camera can control the iris more precisely for better image effect.
- Alarm: 3 in, 2 out; audio: 1 in, 1 out; RS485, BNC, supports max. 256 G Micro SD card
- 12 VDC/24 VAC/PoE power supply (the power ports are different depending on the power supply).
- IP67, IK10 protection grade.
- 12V DC power output, max. current 165mA, easy for installation
- Anti-corrosion coating (optional).



Perimeter Protection

With deep learning algorithm, Dahua Perimeter Protection technology can recognize human and vehicle accurately. In restricted area (such as pedestrian area and vehicle area), the false alarms of intelligent detection based on target type (such as tripwire, intrusion, fast moving, parking detection, loitering detection and gathering detection) are largely reduced.

People Counting

With deep learning algorithm, Dahua People Counting technology can track and process moving human body targets to realize the accurate statistics of enter No., leave No., and In Area No. Working with management platform, it outputs reports to meet your requirements.

Face Detection

Dahua Face Detection technology can detect the face in the image. With deep learning algorithm, the technology supports detecting, tracking, capturing and selecting the best face image, and then outputs face snapshot.

Face Recognition

Dahua Face Recognition technology extracts the features of captured faces and compares them with that in face database to recognize the person identity.

Cyber Security

Dahua network camera is equipped with a series of key security technologies, such as security authentication and authorization, access control, trusted protection, encrypted transmission, and encrypted storage, which improve its security defense and data protection, and prevent malicious programs from invading the device.

Privacy Protection

Dahua Privacy Protection technology can mask the detected face and human body to protect the privacy of some special targets.

PPE Detection

With the PPE Detection function, the camera can detect attributes including face masks, helmets, glasses, safety vests, and the color of tops and bottoms, and determine whether PPE requirements are met. PPE compliance or non-compliance alarms can be triggered according to the alarm settings.

Face and Human Body Association

With deep learning algorithm, Dahua Face and Human Body Association technology detects face and human body of one person, captures them separately, selects the best image, and then associates them.

Technical Specification

Camera	
Image Sensor	1/1.8" CMOS
Max. Resolution	2688 (H) × 1520 (V)
ROM	4 GB
RAM	2 GB
Scanning System	Progressive
Electronic Shutter Speed	Auto/Manual 1/1 s–1/100,000 s
Min. Illumination	0.001 lux@F1.6 (Color, 30 IRE) 0.0002 lux@F1.6 (B/W, 30 IRE) 0 lux (Illuminator on)
S/N Ratio	>56 dB
Illumination Distance	120 m (393.70 ft)
Illuminator On/Off Control	Auto; Manual; Zoomprio
Illuminator Number	4 (IR LED)
Pan/Tilt/Rotation Range	Pan: 0°–360° Tilt: 0°–90° Rotation: 0°–360°
Lens	
Lens Type	Motorized vari-focal
Lens Mount	Module interface
Focal Length	8-32 mm
Max. Aperture	F1.6 (Constant)

Field of View	Horizontal: 41° (W)–15° (T) Vertical: 22° (W)–9° (T) Diagonal: 48° (W)–18° (T)				
Iris Control	Auto; P-iris				
Close Focus Distance	1.0 m (3.28 ft)				
DORI Distance	Lens	Detect	Observe	Recognize	Identify
	W	160 m (524.93 ft)	64 m (209.97 ft)	32 m (104.97 ft)	16 m (52.49 ft)
	T	406.9 m (1334.97 ft)	162.8 m (534.12 ft)	81.4 m (267.06 ft)	40.7 m (133.53 ft)

Smart Event

IVS	Abandoned object; missing object
-----	----------------------------------

Professional, intelligent

IVS (Perimeter Protection)	Intrusion, tripwire, fast moving (the three functions support the classification and accurate detection of vehicle and human); loitering detection, people gathering, and parking detection
Face Detection	Face detection; track; snapshot; snapshot optimization; optimal face snapshot upload; face enhancement; face exposure; face attributes extraction including 6 attributes (gender, age, glasses, expressions, mask, and beard) and 8 expressions (angry, sad, disgusted, scared, surprised, calm, happy, confused); face snapshot set as face or one-inch photo; snapshot strategies (real-time snapshot, quality priority and optimization snapshot); face angle filter; optimization time setting
Face Recognition	Face detection; track; snapshot; snapshot optimization; optimal face snapshot upload; face enhancement; face exposure; face attributes extraction including 6 attributes (gender, age, glasses, expressions, mask, and beard) and 8 expressions (angry, sad, disgusted, scared, surprised, calm, happy, confused); face snapshot set as face or one-inch photo; snapshot strategies (recognition priority and optimization snapshot); face angle filter; optimization time setting. Support 5 face databases; register one by one or in batches; support face recognition similarity settings and face comparison on the basis of 100,000 face databases.
Face and Body Detection	There are two modes: General mode and PPE Detection. General mode: Supports enabling face detection and human detection at the same time, and alarms can be triggered. PPE Detection: Supports PPE detection, can detect attributes including face mask, safety helmet, glasses, and safety vest, top color and bottom color, and determine whether PPE requirements are met. Alarms can be triggered according to the alarm settings.
People Counting	Tripwire people counting and people counting in area; generating and exporting report (day/month/year); queue management and exporting report (day/month); 4 rules can be set for tripwire, people counting in area and queue management.
Video Metadata	Motor vehicle, non-motor vehicle, face, human detection; track; snapshot; snapshot optimization; optimal face snapshot upload. Motor vehicle attributes: license plate, vehicle type, vehicle color, vehicle logo, seatbelt, smoking, calling, etc. Non-motor vehicle attributes: type, color, number of people, top type and color, helmet. Human body attributes: top/bottom type and color, bag, hat, gender, and umbrella. Face attributes: gender, age, expressions, glasses, face mask and beard.
Smart Search	Work together with Smart NVR to perform refine intelligent search, event extraction and merging to event videos

Video

Video Compression	H.265; H.264; H.264H; MJPEG (Only supported by the sub stream)
Smart Codec	Smart H.265+; Smart H.264+
Video Frame Rate	Main Stream: 2688 × 1520 (1–50/60 fps) Sub stream: 704 × 576 (1–25 fps); 704 × 480 (1–30 fps) Third stream: 1920 × 1080 (1–25/30 fps) Fourth stream: 1920 × 1080 (1–25/30 fps) Fifth stream: 704 × 576 (1–25 fps); 704 × 480 (1–30 fps)
Stream Capability	5 streams
Resolution	4M (2688 × 1520); 3M (2304 × 1296); 1080p (1920 × 1080); 1.3M (1280 × 960); 720p (1280 × 720); D1 (704 × 576/704 × 480); VGA (640 × 480); CIF (352 × 288/352 × 240)
Bit Rate Control	CBR/VBR
Video Bit Rate	H.264: 32 kbps–16384 kbps H.265: 12 kbps–9984 kbps
Day/Night	Auto(ICR)/Color/B/W
BLC	Yes
HLC	Yes
WDR	140 dB
Scene Self-adaptation (SSA)	Yes
White Balance	Auto; natural; street lamp; outdoor; manual; regional custom
Gain Control	Auto; Manual
Noise Reduction	3D NR
Motion Detection	OFF/ON (4 areas, rectangular)
Region of Interest (RoI)	Yes (4 areas)
Image Stabilization	Electronic Image Stabilization (EIS)
Smart Illumination	Yes
Defog	Yes
Image Rotation	0°/90°/180°/270° (Support 90°/270° with 2688 × 1520 resolution and lower)
Mirror	Yes
Privacy Masking	4 areas

Audio

Audio Compression	PCM; G.711A; G.711Mu; G.726; G.723
-------------------	------------------------------------

Alarm

Alarm Event	No SD card; SD card full; SD card error; SD card durability warning; network disconnection; IP conflict; illegal access; security exception; motion detection; video tampering; tripwire; intrusion; fast moving; abandoned object; missing object; loitering detection; people gathering; parking detection; scene changing; audio detection; defocus detection; external alarm; face detection; video metadata; people counting in area; people counting; queue management
-------------	--

Network

Network Port	RJ-45 (10/100/1000 Base-T)
SDK and API	Yes

Cyber Security	Video encryption; Firmware encryption; Configuration encryption; Digest; WSSE; Account lockout; Security logs; IP/MAC filtering; Generation and importing of X.509 certification; syslog; HTTPS; 802.1x; Trusted boot; Trusted execution; Trusted upgrade
Network Protocol	IPv4; IPv6; HTTP; TCP; UDP; ARP; RTP; RTSP; RTCP; RTMP; SMTP; FTP; SFTP; DHCP; DNS; DDNS; QoS; UPnP; NTP; Multicast; ICMP; IGMP; NFS; SAMBA; PPPoE; SNMP
Interoperability	ONVIF (Profile S/Profile G/Profile T); CGI; Milestone; P2P
User/Host	20 (Total bandwidth: 80 M)
Storage	FTP; SFTP; Micro SD card (support max. 256 GB); NAS
Browser	IE: IE9 and later Chrome: Chrome 42 and later Firefox: Firefox 48.0.2 and later
Management Software	Smart PSS; DSS; DMSS
Mobile Client	iOS; Android

Certification

Certifications	CE-LVD: EN62368-1; CE-EMC: Electromagnetic Compatibility Directive 2014/30/EU; FCC: 47 CFR FCC Part 15, Subpart B; UL/CUL: UL62368-1 & CAN/CSA C22.2 No. 62368-1-14; UL 50E NEMA Type 4X (optional)
----------------	---

Port

RS-485	1 (baud rate range: 1200 bps–115200 bps)
Audio Input	1 channel (RCA port)
Audio Output	1 channel (RCA port)
Alarm Input	3 channels in: 5 mA 3 V–5 VDC
Alarm Output	2 channels out: 1,000 mA 30 VDC/500 mA 50 VDC

Power

Power Supply	12 VDC/24 VAC/PoE+ (802.3at)
Power Consumption	Basic power consumption: 5.11 W (12 VDC); 6.82 W (24 VAC); 7.62 W (PoE) Max. power consumption (Max. stream + intelligent function + IR LED + focus): 16.8 W (12 VDC); 20.7 W (24 VAC); 21.3 W (PoE) Heat power consumption: 3.3 W (12 VDC); 5.5 W (24 VAC); 5.5 W (PoE)

Environment

Operating Conditions	–40 °C to +65 °C (–40 °F to +149 °F)/Less than 95% RH
Storage conditions	–40 °C to +65 °C (–40 °F to +149 °F)
Protection Grade	IP67, IK10, Anti-Corrosion Protection: NEMA 4X (optional)

Structure

Casing	Metal + plastic
Product Dimensions	340.1 mm × 108.5 mm × 92.9 mm (13.39" × 4.27" × 3.66") (L × W × H)
Net Weight	1.54 kg (3.40 lb)
Gross Weight	2.44 kg (5.38 lb)

Ordering Information

Type	Model	Description
4MP Camera	DH-IPC-HFW7442H-Z4-S2	4MP IR Bullet WizMind Network Camera
	IPC-HFW7442H-Z4-S2	4MP IR Bullet WizMind Network Camera
Accessories (Optional)	PFA154	Pole Mount
	PFM320D	12 VDC 2A Power Adapter
	PFM900-E	Integrated Mount Tester
	TF-P100	MicroSD Memory Card

Dimensions (mm[inch])

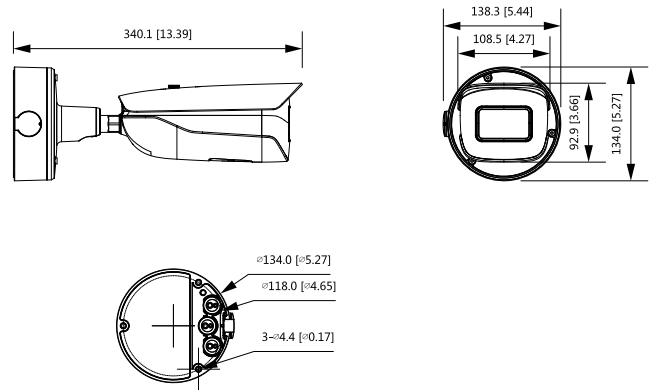

Accessories

Optional:



PFA154 Pole Mount



PFM320D 12 VDC 2A Power Adapter



PFM900-E Integrated Mount Tester



TF-P100 MicroSD Memory Card

